

2024

Electric Service Equipment

METER PEDESTALS • METER SOCKETS • CABINETS • ENCLOSURES



**Updates to this manual may be necessary throughout
the year. Please see
www.alliantenergy.com/servicemanuals
for the most up-to-date information.**



ELECTRIC SERVICE EQUIPMENT

TABLE OF CONTENTS

Issued Jan 2024

GENERAL INFORMATION		Page
E000.	General Information	0-1
E001.	Updates	0-1
E002.	Approval Process	0-1
E003.	Equipment Modification / Continued Listing	0-1
E004.	Manufacturer’s Information & Telephone Numbers	0-2

CHAPTER 1 - METER SOCKETS		Page
E100.	Technical Specifications for Meter Sockets	1-1
	Chapter 1 - Equipment List Headers	1-3
	Chapter 1 - Meter Socket List Notes	1-4

Meter Sockets:

E101.	Residential Meter Sockets - 250V Max	1-5
E101A.	Residential 320A Meter Sockets - 250V Max	1-5
E102.	Residential Meter Sockets with Main & Panel Combo - 250V Max	1-6
E102A.	Residential 320A Meter Sockets with Main - 250V Max	1-7
E103.	Commercial/Residential Meter Sockets - 250V Max	1-8
E104A.	Commercial/Residential Meter Sockets - 480V Max	1-10
E104B.	Commercial/Residential Meter Sockets with Main - 480V Max	1-10
E105.	Commercial/Residential Instrument Transformer Rated Meter Sockets	1-11
E106.	Commercial/Residential Meter Sockets with Main - 250V Max	1-12
E106A.	Commercial/Residential Alternate Energy Sockets w/ Main	1-12
E106B.	Commercial/Residential with Dual Lug Sockets - 250V Max	1-13
E106C.	Communications Meter Disconnect Combo	1-13

Group Metering (Non-Modular):

E107.	Multi-position Residential: Horizontal (2-6 meters)	1-14
E108.	Multi-position Commercial/Residential: Horizontal (2-6 meters)	1-15
E109.	Multi-position Commercial/Residential: Vertical (2-6 meters)	1-15
E110.	Residential All-in-one Meter Packs (2-6 meters)	1-16
E111.	Commercial/Residential All-in-one Meter Packs (2-6 meters)	1-16

Pedestals:

E112.	Residential Meter Pedestals - 250 Volts Max	1-17
E112A.	Residential 320A Meter Pedestals	1-17
E113.	Residential Meter Pedestals with Main - 250 Volts Max	1-18
E113A.	Residential 320A Meter Pedestals with Main - 250V Max	1-18
E114.	Commercial/Residential Meter Pedestals - 250V Max	1-19
E115.	Commercial/Residential Meter Pedestals with Main - 250V Max	1-20 & 1-21
E116.	Manufactured Home Meter Pedestals with Main - 250V Max	1-22



E117. Recreational Vehicle Meter Pedestals with Main – 250V Max..... 1-22

Temporary:

E118. Temporary Residential Only Equipment 120/240V 1PH..... 1-23

E119. Temporary Commercial/Residential Equipment 120/240V or 120/208V 1PH..... 1-23

IA OH (WI MAINTENANCE ONLY):

E101M. Residential Meter Sockets - 250V Max 1-24

E102M. Residential Meter Sockets with Main & Panel Combo - 250V Max 1-25

E103M. Commercial/Residential Meter Sockets - 250V Max 1-26

E104AM. Commercial/Residential Meter Sockets - 480V Max 1-27

E104BM. Commercial/Residential Meter Sockets - 480V Max 1-27

E105M. Commercial/Residential Instrument Transformer Rated Meter Sockets 1-27

E106M. Commercial/Residential Meter Sockets with Main - 250V Max 1-28

E106BM. Commercial/Residential with Dual Lug Sockets – 250V Max 1-28

E107M. Multi-position Residential: Horizontal (2-6 meters) 1-29

E109M. Multi-position Commercial/Residential: Vertical (2-6 meters) 1-29

E110M. Residential All-in-one Meter Packs (2-6 meters) 1-29

E118M. Temporary Residential Only Equipment 120/240V 1PH..... 1-29

E119M. Temporary Commercial/Residential Equipment 120/240V or 120/208V 1PH..... 1-29

CHAPTER 2 - METER CABINETS

Page

E200. Technical Specifications for Metering Transformer Cabinets & Conductor Termination Boxes2-1
Acceptance.....2-1
Specifications / Requirements2-1
Current Transformer Mounting Bar Requirements2-3
Cable Space Requirements & Cabinet Specifications.....2-4 to 2-7
Chapter 2 - Equipment List Headers.....2-8
Chapter 2 - Equipment List Notes2-9

Metering Transformer Cabinets:

E201A.	Metering Transformer Cabinets - 400 Amps (Residential Only).....	2-10
E201.	Metering Transformer Cabinets - 400 Amps	2-10 & 2-11
E202A.	Metering Transformer Cabinets - 600 Amp (Residential Only)	2-12
E202.	Metering Transformer Cabinets - 600 Amps	2-12 & 2-13
E203.	Metering Transformer Cabinets - 800 Amps	2-14 & 2-15
E204.	Metering Transformer Cabinets - 1200 Amps	2-16
E205.	Metering Transformer Cabinets - 1600 Amps	2-17
E206.	Metering Transformer Cabinets - 2000 Amps	2-17
E207.	Metering Transformer Cabinets - 2500 Amps	2-18
E208.	Metering Transformer Cabinets - 3000 Amps	2-18

Combination Metering Transformer Cabinets with Main:

E209.	Metering Transformer Cabinets w/Main - 400 Amps.....	2-19 & 2-20
E210.	Metering Transformer Cabinets w/Main - 600 Amps.....	2-21
E211.	Metering Transformer Cabinets w/Main - 800 Amps.....	2-22
E212.	Metering Transformer Cabinets w/Main - 1200 Amps.....	2-23
E213.	Metering Transformer Cabinets w/Main - 1600 Amp	2-24
E214.	Metering Transformer Cabinets w/Main - 2000 Amps.....	2-24
E215.	Metering Transformer Cabinets w/Main - 2500 Amps.....	2-24
E216.	Metering Transformer Cabinets w/Main - 3000 Amps.....	2-24

Termination Boxes:

E217.	Termination Boxes - 400 Amps Max	2-25
E218.	Termination Boxes - 600 Amps Max	2-26
E219.	Termination Boxes - 800 Amps Max	2-27
E220.	Termination Boxes - 1200 Amps Max	2-28
E221.	Termination Boxes - 1600 Amps Max	2-28
E222.	Termination Boxes - 2000 Amps Max	2-29
E223.	Termination Boxes - 2500 Amps Max	2-29
E224.	Termination Boxes - 3000 Amps Max	2-29



CHAPTER 3 - ADDITIONAL EQUIPMENT INFORMATION	Page
E300. Scope	3-1
Horizontal Bussed Equipment:	
E301. Multi-position Residential: Modular (bussed sections)	3-2
E302. Multi-position Commercial/Residential: Modular (bussed sections)	3-3 & 3-4
E303A. Bussed Metering Transformer Cabinets w/Main - 400A.....	3-5
E303B. Bussed Termination Boxes - 400A.....	3-5
E303C. Bussed Termination Box w/Main - 400A	3-5
E304A. Bussed Metering Transformer Cabinets w/Main - 600A.....	3-6
E304B. Bussed Termination Boxes - 600A.....	3-6
E304C. Bussed Termination Box w/Main - 600A	3-6
E305A. Bussed Metering Transformer Cabinets w/Main - 800A.....	3-7
E305B. Bussed Termination Boxes - 800A.....	3-7
E305C. Bussed Termination Box w/Main - 800A	3-7
E306A. Bussed Metering Transformer Cabinets w/Main - 1200A.....	3-8
E306B. Bussed Termination Boxes - 1200A.....	3-8
E306C. Bussed Termination Box w/Main - 1200A	3-8
E307. Electric Vehicle Charger Metering Transformer Cabinets.....	3-9
E308. (SECTION NOT USED)	
E309. Switchboard Structures 400 to 3000 Amps	3-9 to 3-12
E310. Primary Metering Enclosures	3-13 & 3-14
E311. Transfer Switches (Site Isolating Devices).....	3-15
311A. Farmstead Pole Top Transfer Switches – 250 Volt Max	3-15
311B. Farmstead Pole Top Transfer Switches – 600 Volt Max	3-15
311C. Residential Grade Level Transfer Switches w/Meter Socket – 250 Volt Max.....	3-15
E311D. Residential Grade Level Transfer Switches – 250V Max	3-16 & 3-17
E311E. Level Operated – Primary Voltage Pole Top Load Break Switch.....	3-17
E311F. Automatic Transfer Switches - 240V, 300 Amp Max.....	3-18 & 3-19
E311G1. Grade Level Automatic Transfer Switches – 240V, Single- Phase.....	3-20
E311G2. Grade Level Automatic Transfer Switches – 480V, Single- Phase.....	3-20
E311H1. Grade Level Automatic Transfer Switches – 240V, Three-Phase.....	3-21
E311H2. Grade Level Automatic Transfer Switches – 480V, Three-Phase.....	3-21
E312. Underground Service Wireways	3-22
E313. Three Phase Pad-mount Transformer Pads.....	3-22
E314. Overhead to Underground Service Conversion Kit	3-23



ELECTRIC SERVICE EQUIPMENT

GENERAL INFORMATION

Issued Jan 2024

ELECTRIC SERVICE EQUIPMENT – GENERAL INFORMATION

E000. GENERAL INFORMATION

Use of the name Alliant Energy in this Electric Service Equipment (ESE) e-manual refers to the electric utility operations for Interstate Power and Light (IP&L) and Wisconsin Power & Light (WP&L).

E001. UPDATES

This edition became effective **January 2023** and supersedes all earlier editions.

Electronic updates to the Electric Service Equipment e-manual will be made periodically and may be found on the Alliant Energy web site: alliantenergy.com/servicemanuals.

References in this e-manual are made to Alliant Energy's Electric Service Rules (ESR) e-manual.

E002. APPROVAL PROCESS

In order to be listed in the ESE e-manual, manufacturer's equipment application information, technical specifications and dimensional drawings (not marketing material or catalog pages) shall be submitted for review by **June 1st** each year to:

Alliant Energy Standards Engineering
ESR_Team@alliantenergy.com
4902 N. Biltmore Lane
Madison, WI 53718

The manufacturer will then be invited to present their equipment at an ESE meeting. Equipment that meets Alliant Energy specifications and requirements listed in this e-manual will be allowed for a one-time installation field test. Once the field test shows the equipment to be satisfactory, a letter verifying temporary approval will be provided. The equipment will then be listed in the next published edition of the ESE e-manual.

ESE equipment review meetings are typically held each year in **April** and **August** as needed.

E003. EQUIPMENT MODIFICATION/CONTINUED LISTING

If equipment specifications are modified, manufacturers must explain their intent and submit new drawings by **June 1st** each year for review and approval to remain listed the following year.



ELECTRIC SERVICE EQUIPMENT

GENERAL INFORMATION

Issued Jan 2024

E004. MANUFACTURER'S INFORMATION & TELEPHONE NUMBERS

Manufacturer's telephone numbers and websites are provided to assist customers and their contractors in finding an area supplier of the equipment shown.

MANUFACTURER	PHONE	WEBSITE
American Midwest Power (AMP)	1-800-328-8658	www.ampmfg.com
Briggs & Stratton	1-800-732-2989	www.briggsandstratton.com
Brooks Utility Products	1-888-687-3008	www.brooksutility.com
Concast	1-507-732-4095	www.concastinc.com
Dalmaray Concrete Products	1-608-752-6507	www.dalmaray.com
Durham	1-417-532-7121	www.durhamusa.com
Eaton/Cutler Hammer	1-800-356-1243	www.eaton.com
Electri-Glass, Inc	1-731-427-0433	www.electri-glass.com
Electro-Mechanical Industries, Inc. (EMI)	1-800-536-3678	www.e-m-i.com
Elliot Industries, Inc.	1-318-746-3296	www.elliott-industries.com
Erickson Electrical Equipment	1-800-952-7225	www.ericksonelectric.com
Galva-Closure Products Co.	1-608-873-3044	www.ctcabinets.com
GE	1-800-431-7867	www.electrification.us.abb.com
Generac	1-888-436-3722	www.generac.com
Hubbell Power Systems, Inc.	1-573-682-5521	www.hubbellpowersystems.com
Landis + Gyr	1-800-428-7853	www.landisgyr.com
Midwest Electric Products	1-507-345-2543	www.midwestelectric.com
Milbank	1-877-483-5314	www.milbankworks.com
Nordic Fiberglass, Inc.	1-218-745-5095	www.nordicfiberglass.com
Ronk Electrical Industries	1-800-221-7665	www.ronkelectrical.com
S&C	1-800-621-5546	www.sandc.com
Siemens/Talon/Murray	1-800-333-7732	www.siemens.com/us
Square-D/Schneider Electric	1-888-778-2733	www.schneider-electric.us
Tesco Controls, Inc	1-800-948-3726	www.tescocontrols.com
Tesco/Advent	1-800-762-8211	www.tesco-advent.com



ELECTRIC SERVICE EQUIPMENT

METER SOCKETS

Issued Jan 2024

CHAPTER 1

ELECTRIC SERVICE EQUIPMENT – METER SOCKETS

E100. TECHNICAL SPECIFICATIONS FOR METER SOCKETS

A. ACCEPTANCE

1. Only meter sockets, group meter assemblies, modular meter assemblies and meter pedestals listed in this e-manual are acceptable for use in Alliant Energy service territories.
2. All meter sockets, meter pedestals, group meter assemblies, and modular meter assemblies shall be listed by an independent testing agency (such as UL) for the specified voltage and amperage rating indicated, and carry the testing agency's listing mark.
3. Equipment installed, which has not been approved for use by Alliant Energy, will not be accepted. In order to assure interconnection please utilize the equipment listed in the equipment section for the applications shown.
4. All sockets shall be inspected and approved by Alliant Energy to ensure they meet our requirements. Alliant Energy will not approve the use of altered, rusted, damaged or modified equipment.
5. The complete catalog number, as shown in the ESE e-manual, shall be included as part of the equipment nameplate.
6. Equipment shall only be used for its intended purpose.

B. SPECIFICATIONS / REQUIREMENTS

1. RESIDENTIAL METER SOCKETS

All residential meter-sockets shall be a ring-less type, equipped with a manually operated bypass (either horn for 200 amps or less or lever for up to 320 amps), have individual covers and be listed in the ESE e-manual.

2. COMMERCIAL, FARM AND NON-RESIDENTIAL METER SOCKETS

All commercial, farm and non-residential meter-sockets shall be a ring-less type, equipped with an approved locking jaw lever bypass capable of carrying full rated continuous duty current, have individual covers and be listed in the ESE e-manual.

3. UNDERGROUND SERVICE

- a) An individual self-contained 100 amp metering equipment is the minimum allowed.
- b) Set-screw type or lay-in type terminal lug connectors shall be provided on all metering devices. These lugs shall be rated to accept conductor sizes from #6 to 350 kcmil.
- c) Individual self-contained sockets shall have a minimum bending radius of 11 inches.
- d) Individual self-contained sockets shall have an overall height of at least 14 inches.

4. OVERHEAD SERVICE

The customer furnishes, installs and maintains overhead service except for Alliant Energy's

ELECTRIC SERVICE EQUIPMENT

METER SOCKETS

Issued Jan 2024

service drop, connectors and cable dead-end. Customer electrician will install wiring from weatherhead into the meter socket.

5. SINGLE PHASE NETWORK METERING

Permanent or added 5th terminals shall be installed horizontally, in the nine o'clock position, and be of the screw-in type, unless otherwise approved by Alliant Energy.

6. GROUNDING & BONDING

Grounding and bonding of some meter socket installations and bonding conductor sizes are shown in ESR e-manual Chapter 14.

7. FACTORY INSTALLED BREAKERS

All metering devices: meter sockets, meter packs, cross bussed modular metering panels, group meter assemblies and metering transformer cabinets listed in the ESE e-manual with breaker devices shall only be acceptable when the breakers have been factory installed. If these breakers are changed out for any reason other than faulty operation, the device will be considered unacceptable for use in the Alliant Energy service areas.

C. TABLE 1 - METER SOCKET SELECTION

Service Type	Phase	Wire	Voltage	Max. Amps	Terminals	Meter Form #
SELF-CONTAINED						
Single Phase - Commercial	1	3	120/240	300	4	2S
Single Phase - Residential	1	3	120/240	320	4	2S
Network Single Phase (1)	1	3	120/208	200	5	12S
Four Wire WYE	3	4	120/208	300	7	16S
Four Wire WYE OH Only	3	4	277/480	200	7	16S
CURRENT TRANSFORMER RATED						
Single Phase - IPL Only	1	3	120/240	20	5	3S
Single Phase - WPL Only	1	3	120/240	100	5	3S
Single Phase CT Cab. - IPL Only	1	3	120/240	20	6	4S
Four Wire WYE	3	4	120/208	20	13	9S
Four Wire WYE	3	4	277/480	20	13	9S
MAINTENANCE ONLY						
Single Phase CT Cab. (2)	1	3	120/208	20	8	5S/45S
Four Wire Delta (3)	3	4	120/240	20	13	9S
Three Wire Delta (4)	3	3	120/240	20	8	5S/45S

1. Network Meters - The fifth terminal shall be installed horizontally in the nine o'clock position. Permanent or added fifth position terminals shall be of the screw-in-type, unless otherwise approved by Alliant Energy Engineering.

2. 8-terminal socket is for 120/208 1-phase network metering transformer cabinets for maintenance purposes only (Not for new installations).
3. This meter socket is for 3 or 4-wire delta & 4-wire wye maintenance only.
4. This meter socket is for 3 wire delta maintenance only.

CHAPTER 1 - EQUIPMENT LIST HEADERS:

1. **Amps** - Amp rating of device
2. **Term.** - Number of terminals in meter socket
3. **Ph.** - The number of phases
 1PH = single-phase
 3PH = three-phase
4. **Use** - Alliant Energy approved use of the device
 OH/UG = Approved for overhead and underground applications
 UG = Approved for underground applications only
 OH = Approved for overhead applications only
5. **Manufacturer** - Manufacturer of device
6. **Catalog Number** - Manufacturer identification number for the device.
7. **Bypass:** The meter socket selection is tied to the established account designation.
 Horn = By-pass for residential applications.
 Horn by-pass shall not be used in commercial applications.
 Lever = By-pass normally for commercial applications.
 Lever by-pass may be used for residential applications.
 Test Sw. = Instrument rated meter sockets with test switches
8. **Mount Type** - How the meter socket is mounted at customer location
 Wall = Bolted or Lagged to a wall
 Panel = Multiple Meters are mounted in a panel of meters - Group or Modular
 Pad = Mounted on a concrete pad with conduit ingress and egress
 Post = Free standing on a post – direct bury residential or mobile home pedestals, etc
9. **SCCR – Short Circuit Current Rating (SCCR)** is the maximum current (amps) the device will withstand and without damage and/or failure
10. **Notes** - References applicable Note(s) on page 1-4 or below each section.

SPECIAL CHARACTERS USED:

- # - Any number for available options may be inserted into this part number
- * - Any number or letter for available options may be inserted into this part number
- () - Approved from multiple manufacturers, see note below

ELECTRIC SERVICE EQUIPMENT**METER SOCKETS****Issued Jan 2024**

In some instances the same meter socket catalog numbers are followed by:

CH (Eaton-Cutler Hammer), MEP (Midwest Electric Products) or SQD (Square-D)

These are Durham sockets with Eaton-Cutler Hammer, Midwest Electric or Square-D labels.

If you need information on these devices, please contact The Durham Company at 417-532-7121.

CHAPTER 1 - METER SOCKET LIST NOTES:

- (1) - () = (blank) Durham, (CH) Eaton-Cutler Hammer, (E) Eaton, (MEP) Midwest Electric Products or (SQD) Square-D
- (2) UHT, UGHT, UTH, UGTH, UT & UGT Series: * = Select desired bolt-on hub or top configuration
- (3) # = Multiple catalog numbers, approved for positions as shown next to catalog number
- (4) 4040 Series: 1st # = 2, 3, 4, 5 or 6 for number of positions, 2nd # = 0: for 2-3 position or 2: for 4-6 position; Must order 22k Breakers (Main UQFPH) & Series Kit 4714
- (5) CM0 Series: 1st # = Select number: 2 or 3 for number of positions, 2nd # = 5: 400A bus, 6: 600A bus
- (6) TMMR Series: 1st # = 2: 200A bus, 4:400A bus, 6:600A bus, 2nd # = 2, 3, 4, 5 or 6 for number of positions
- (7) WP Series: 1st # = 2, 3, 4, 5 or 6 for bus amperage, 2nd # = 3, 4, 5 or 6 for number of positions
- (8) MPH Series: 1st # = bus: 2: 200A, 3:300A, 4:400A, 5:500A 6:600A, 8:800A; 2nd # = 2, 3, 4, 5 or 6 for positions
- (9) 1MP#12#RRLB: 1st # = 2, 3, 4, 5 or 6 for number of positions, 2nd # = 2: 200A bus, 4:400A bus, 6:600A bus
- (10) Extension Kit or Stabilizer Foot required for freestanding, direct buried, pad or post-mount. Contact manufacturer for details and part number.
- (11) CP3 Series: * = Both "A" and "B" approved, *** = Remainder of part number is customizable to specific installation
- (12) Tesco Pedestal: Approved for use only with an approved meter socket listed in ESE Chapter 1
- (13) Specify Milbank Series K5400-Bridge-(XXX) receptacle/circuit breaker kits as needed for manufactured home power supply cord or other convenience receptacle
- (14) T-Series: *** = Choose Receptacle Options to meet project needs
- (15) Combination non-fused cold sequence disconnect, 200A 3Ph self-contained socket

Maintenance Only Notes:

- (16) CHR: # = 1-7 receptacle selection, * = N/G breaker selection

ELECTRIC SERVICE EQUIPMENT

METER SOCKETS

Issued Jan 2024

Manufacturer	Use	Catalog Number	Bypass	Mount	SCCR	Notes
E101. Residential Meter Sockets - 250V Max						
120/240V 1PH 4-Terminal 200 Amp						
Durham, Eaton-Cutler Hammer or Midwest Electric Products						
	OH/UG	UHTRS233*(-)	Horn	WALL	10kA	(1)(2)
	UG	UHTRS223A(-)	Horn	WALL	10kA	(1)
Milbank						
	UG	U3850-0-TG-KK-ALT	Horn	WALL	10kA	
Siemens/Talon						
	UG	UAS877-[PPGP or PPZA]	Horn	WALL	10kA	
120/208V 1PH 5-Terminal 200 Amp						
Durham, Eaton-Cutler Hammer or Midwest Electric Products						
	OH/UG	UGHTRS233*(-)	Horn	WALL	10kA	(1)(2)
	UG	UGHTRS223A(-)	Horn	WALL	10kA	(1)
Milbank						
	UG	U3850-0-TG-KK-5T	Horn	WALL	10kA	
E101A. Residential 320A Meter Sockets - 250V Max						
120/240V 1PH 4-Terminal 320 Amp						
Durham, Eaton-Cutler Hammer, Midwest Electric Products, or Square-D						
	UG	1008540(-)	Lever	WALL	10kA	(1)
Durham, Eaton-Cutler Hammer or Midwest Electric Products						
	OH/UG	1008541(-)	Lever	WALL	10kA	(1)
Milbank						
	UG	U1797-O-K3L-K2L-ALT	Lever	WALL	10kA	
	UG	U3000-O-K3L-K2L-ALT	Lever	WALL	10kA	
Siemens/Talon						
	OH/UG	48104-82WI (60162 Lugs)	Lever	WALL	10kA	
	OH/UG	48704-82GP	Lever	WALL	10kA	
	UG	48004-82	Lever	WALL	10kA	

NOTES:

- (1) - (-) = (blank) Durham, (CH) Eaton-Cutler Hammer, (E) Eaton, (MEP) Midwest Electric Products or (SQD) Square-D
- (2) UHT, UGHT, UTH, UGTH, UT, USTS & UGT Series: * = Select desired bolt-on hub or top configuration

OH only sockets have been moved to a maintenance only section: E101M



Pictured: UAS877-PPGP



Pictured: 48704-82GP

ELECTRIC SERVICE EQUIPMENT

METER SOCKETS

Issued Jan 2024

Manufacturer	Use	Catalog Number	Bypass	Mount	SCCR	Notes
E102. Residential Meter Sockets with Main & Panel Combo - 250V Max						
120/240V 1PH 4-Terminal 100 Amp						
Milbank						
	OH/UG	U5168-XTL-100-KK-ALT	Horn	WALL	10kA	
Siemens/Talon						
	OH/UG	LG0816B1100RBT	Horn	WALL	22kA	
	OH/UG	LG0816B1125RBT	Horn	WALL	22kA	
120/240V 1PH 4-Terminal 150 Amp						
Milbank						
	OH/UG	U5168-XTL-150-KK-ALT	Horn	WALL	22kA	
Siemens/Talon						
	OH/UG	LG0816B1150RBT	Horn	WALL	22kA	
Leviton						
	OH/UG	LP815-HMC/LS815-BHD	Horn	WALL	22kA	
120/240V 1PH 4-Terminal 200 Amp						
Eaton-CH						
	OH/UG	MB200BTSD	Horn	WALL	22kA	
Midwest Electric						
	OH/UG	R281CB1	Horn	WALL	22kA	
Milbank						
	OH/UG	U5168-XTL-200-KK-ALT	Horn	WALL	22kA	
Siemens/Talon						
	OH/UG	LG0816B1200RBT	Horn	WALL	22kA	
	OH/UG	UAB417-XG (note: utility on right side)	Horn	WALL	10kA	
Leviton						
	OH/UG	LP820-HMC/LS820-BHD	Horn	WALL	10kA	
120/208V 1PH 5-Terminal 100 Amp						
Siemens/Talon						
	OH/UG	LGMM0202B1125RJBX	Horn	WALL	22kA	
	OH/UG	MM0202B1125RJBX	Horn	WALL	22kA	
	OH/UG	MC0816B1100RJB	Horn	WALL	22kA	
120/208V 1PH 5-Terminal 150 Amp						
Siemens/Talon						
	OH/UG	LGMM0202B1150RJBX	Horn	WALL	22kA	
	OH/UG	MM0202B1150RJBX	Horn	WALL	22kA	
	OH/UG	MC0816B1150RJB	Horn	WALL	22kA	
120/208V 1PH 5-Terminal 200 Amp						
Eaton-CH						
	OH/UG	MB816B200BTSD	Horn	WALL	22kA	
Milbank						
	OH/UG	U5168-XTL-200-KK-5T	Horn	WALL	22kA	
Siemens/Talon						
	OH/UG	LGMM0202B1200RJBX	Horn	WALL	22kA	
	OH/UG	MC0816B1200RJB	Horn	WALL	22kA	
	OH/UG	MM0202B1200RJBX	Horn	WALL	22kA	

OH only sockets have been moved to a maintenance only section: E102M

Pictured: U5168-XTL-100-KK-ALT



ELECTRIC SERVICE EQUIPMENT

METER SOCKETS

Issued Jan 2024

Manufacturer	Use	Catalog Number	Bypass	Mount	SCCR	Notes
E102A. Residential 320A Meter Sockets with Main - 250V Max						
120/240V 1PH 4-Terminal 320 Amp						
Milbank						
	OH/UG	U6585-X-2-200-K3L	Lever	WALL	22kA	
	OH/UG	U6227-X-400-K3L	Lever	WALL	22kA	
	OH/UG	U6228-X-400-K3L	Lever	WALL	22kA	
	OH/UG	U5059-X-2/200-K3L	Lever	WALL	22kA	
	OH/UG	6602-X-2/200-MLK	Lever	WALL	22kA	
Ronk						
	UG	MSB320LK3-UG	Lever	WALL	25kA	

OH only sockets have been moved to a maintenance only section: E102M

Pictured: U5168-XTL-100-KK-ALT



ELECTRIC SERVICE EQUIPMENT

METER SOCKETS

Issued Jan 2024

Manufacturer	Use	Catalog Number	Bypass	Mount	SCCR	Notes
E103. Commercial/Residential Meter Sockets - 250V Max						
120/240V 1PH 4-Terminal 200 Amp						
Brooks Utility Products						
	OH/UG	601U43V3B41-B20A00-MK	Lever	WALL	22kA	
Milbank						
	OH/UG	U6513-XL-BL-ALT	Lever	WALL	10kA	
	UG	U4721-O-BL-ALT	Lever	WALL	10kA	
Siemens/Talon						
	OH/UG	9804-8947	Lever	WALL	10kA	
120/240V 1PH 4-Terminal 300 Amp						
Brooks Utility Products						
	OH/UG	601U49V3B42-B32A00-MK	Lever	WALL	22kA	(1)
Durham, Eaton-Cutler Hammer or Midwest Electric Products						
	OH/UG	1008541-()	Lever	WALL	10kA	(1)
Durham, Eaton-Cutler Hammer, Midwest Electric Products, or Square-D						
	UG	1008540-()	Lever	WALL	10kA	(1)
Milbank						
	UG	U1797-O-K3L-K2L-ALT	Lever	WALL	10kA	
	UG	U3000-O-K3L-K2L-ALT	Lever	WALL	10kA	
Siemens/Talon						
	OH/UG	48104-82WI (60162 Lugs)	Lever	WALL	10kA	
	OH/UG	48704-82GP	Lever	WALL	10kA	
	UG	48004-82	Lever	WALL	10kA	
120/208V 1PH 5-Terminal 200 Amp						
Brooks Utility Products						
	OH/UG	601U43V3B51-B20A00-MK	Lever	WALL	22kA	
Milbank						
	OH/UG	U6513-XL-BL-ALT	Lever	WALL	10kA	
Siemens/Talon						
	OH/UG	48805-0BNU	Lever	WALL	10kA	
120/208V 1PH 5-Terminal 300 Amp						
Brooks Utility Products						
	OH/UG	601U49V3B52-B32A00-MK	Lever	WALL	10kA	

NOTES:

(1) -() = (blank) Durham, (CH) Eaton-Cutler Hammer, (E) Eaton, (MEP) Midwest Electric Products or (SQD) Square-D

OH only sockets have been moved to a maintenance only section: E103M

Pictured: 48707-82



ELECTRIC SERVICE EQUIPMENT

METER SOCKETS

Issued Jan 2024

Manufacturer	Use	Catalog Number	Bypass	Mount	SCCR	Notes
E103. Commercial/Residential Meter Sockets - 250V Max (continued)						
120/208V 3PH 7-Terminal 200 Amp						
Brooks Utility Products						
	OH/UG	601U43V3B71-B20A00-MK	Lever	WALL	22kA	
Milbank						
	OH/UG	U1493-X-ALT	Lever	WALL	10kA	
120/208V 3PH 7-Terminal 300 Amp						
Brooks Utility Products						
	OH/UG	601U49V3B72-B32A00-MK	Lever	WALL	22kA	
Durham, Eaton-Cutler Hammer, Midwest Electric Products, or Square-D						
	OH/UG	1008543-()	Lever	WALL	10kA	(1)
Milbank						
	OH/UG	U2594-X-K7-ALT	Lever	WALL	10kA	
	UG	U2120-X-K7	Lever	WALL	10kA	
Siemens/Talon						
	OH/UG	48707-[029 or 82]	Lever	WALL	10kA	(20)

NOTES:

(1) -() = (blank) Durham, (CH) Eaton-Cutler Hammer, (E) Eaton, (MEP) Midwest Electric Products or (SQD) Square-D

(20) 48707-029 Dosnt include lugs 48707-82 Does include lugs.

OH only sockets have been moved to a maintenance only section: E103M

Pictured: 48707-82



ELECTRIC SERVICE EQUIPMENT

METER SOCKETS

Issued Jan 2024

Manufacturer	Use	Catalog Number	Bypass	Mount	SCCR	Notes
E104A. Commercial Meter Sockets - 480V Max						
277/480V 3PH 7-Terminal 200 Amp						
Milbank						
	OH/UG	U1493-X-ALT	Lever	WALL	10kA	
	OH/UG	U2594-X-K7-ALT	Lever	WALL	10kA	
	UG	U4910-O-BL-ALT	Lever	WALL	10kA	
Murray/Siemens						
	OH/UG	RH173GR	Lever	WALL	10kA	
Siemens/Talon						
	OH/UG	48807-02NU	Lever	WALL	10kA	
	OH/UG	48907-82GP	Lever	WALL	10kA	
E104B. Commercial/Residential Meter Sockets with Main - 480V Max						

OH only sockets have been moved to a maintenance only section: E104M

Pictured: U2594-X-K7-ALT



ELECTRIC SERVICE EQUIPMENT

METER SOCKETS

Issued Jan 2024

Manufacturer	Use	Catalog Number	Bypass	Mount	SCCR	Notes
E105. Commercial/Residential Instrument Transformer Rated Meter Sockets						
1PH 5-Terminal 20 Amp IPL ONLY						
Milbank						
	OH/UG	UC7446-XL-121-ALT (IP&L)	Test Sw.	WALL	10kA	
Siemens/Talon						
	OH/UG	9837-0935(IP&L)	Test Sw.	WALL	10kA	
1PH 6-Terminal 20 Amp IPL ONLY						
Milbank						
	OH/UG	UC7532-XL-401-ALT (IP&L)	Test Sw.	WALL	10kA	
Siemens/Talon						
	OH/UG	9837-0934(IP&L)	Test Sw.	WALL	10kA	
1PH 5-Terminal 100 Amp WPL ONLY						
Durham, Eaton-Cutler Hammer, Midwest Electric Products, or Square-D						
	OH/UG	UGHTRS101*(-)	Horn	WALL	10kA	(1)(2)
	OH/UG	UGHTRS111*(-)	Horn	WALL	10kA	(1)(2)
Milbank						
	OH/UG	U7487-RL-TG-KK-5T	Horn	WALL	10kA	
3PH 13-Terminal 20 Amp IPL ONLY						
Brooks Utility Products						
	OH/UG	602U3060B13-1541 MK (IP&L)	Test Sw.	WALL	10kA	
Durham, Eaton-Cutler Hammer or Midwest Electric Products						
	OH/UG	USTS132*101-() (IP&L)	Test Sw.	WALL	10kA	(1)
Erickson Electric						
	OH/UG	UC7449XL871 (IP&L)	Test Sw.	WALL	10kA	
Milbank						
	OH/UG	UC7449-XL-871-ALT (IP&L)	Test Sw.	WALL	10kA	
Siemens/Talon						
	OH/UG	9837-0932(IP&L)	Test Sw.	WALL	10kA	
	OH/UG	9837-0933(IP&L)	Test Sw.	WALL	10kA	
TESCO/ADVENT						
	OH/UG	9070111(IP&L)	Test Sw.	WALL	10kA	
3PH 13-Terminal 20 Amp WPL ONLY						
Brooks Utility Products						
	OH/UG	602U3060B13-1542 MK (WP&L)	Test Sw.	WALL	10kA	
Durham, Eaton-Cutler Hammer or Midwest Electric Products						
	OH/UG	USTS132*(-) (WP&L)	Test Sw.	WALL	10kA	(1)
Erickson Electric						
	OH/UG	W-340(WP&L)	Test Sw.	WALL	10kA	
Milbank						
	OH/UG	UC7449-XL (WP&L)	Test Sw.	WALL	10kA	
Siemens/Talon						
	OH/UG	9837-8503(WP&L)	Test Sw.	WALL	10kA	
TESCO/ADVENT						
	OH/UG	9070122(WP&L)	Test Sw.	WALL	10kA	

NOTES:

(2) UHT, UGHT, UTH, UGTH, UT, USTS & UGT Series: * = Select desired bolt-on hub or top configuration

OH only sockets have been moved to a maintenance only section: E105M

Pictured: UC7449-XL-87-ALT





ELECTRIC SERVICE EQUIPMENT

METER SOCKETS

Issued Jan 2024

Manufacturer	Use	Catalog Number	Bypass	Mount	SCCR	Notes
E106. Commercial/Residential Meter Sockets with Main - 250V Max						
120/240V 1PH 4-Terminal 100 Amp						
Milbank						
	OH/UG	U5871-XL-100	Lever	WALL	22kA	(17)
120/240V 1PH 4-Terminal 200 Amp						
Midwest Electric						
	OH/UG	R281CB1034	Lever	WALL	22kA	(17)
Milbank						
	OH/UG	U6012-XL-200-K1	Lever	WALL	22kA	(17)
	OH/UG	U3995-XL-200	Lever	WALL	22kA	(17)
	OH/UG	U5871-XL-200	Lever	WALL	22kA	(17)
Leviton						
	OH/UG	LP820-LMC/LS820-BLD	Lever	WALL	22kA	(17)
	OH/UG	LP815-LMC/LS815-BLD	Lever	WALL	22kA	
Ronk						
	UG	MSB200LC-UG	Lever	WALL	22kA	
120/240V 1PH 4-Terminal 300 Amp						
Milbank						
	OH/UG	U4835-X-2/150-K3-BL	Lever	WALL	22kA	
	OH/UG	U4835-X-200/100-K3-BL	Lever	WALL	22kA	
	OH/UG	U6585-X-200-100-K3L-ALT	Lever	WALL	22kA	
	OH/UG	U6585-X-2-150-K3L	Lever	WALL	22kA	
	OH/UG	U6227-X-300-K3L	Lever	WALL	22kA	
	OH/UG	U6228-X-300-K3L	Lever	WALL	22kA	
	OH/UG	U5059-X-2-150-K3L-ALT	Lever	WALL	22kA	
	OH/UG	U5059-X-200-100-K3L-ALT	Lever	WALL	22kA	
	OH/UG	6602-X-200/100MLK	Lever	WALL	10kA	
	OH/UG	6602-X-2/150MLK	Lever	WALL	10kA	
	UG	U4031-O-2/150-K3	Lever	WALL	22kA	
	UG	U4031-O-200/100-K3	Lever	WALL	22kA	
Siemens/Talon						
	OH/UG	MK0402L1400RLM	Lever	WALL	22kA	
Ronk						
	UG	MSB320LJ3-UG	Lever	WALL	25kA	
120/208V 1PH 5-Terminal 200 Amp						
Milbank						
	OH/UG	U6012-XL-200-K1-5T9	Lever	WALL	22kA	
Siemens/Talon						
	OH/UG	MC0408B1200JLT	Lever	WALL	22kA	
	OH/UG	MM0202B1200RLC	Lever	WALL	22kA	
Leviton						
	OH/UG	LP815-5MC/LS815-B5D	Lever	WALL	22kA	
	OH/UG	LP820-5MC/LS820-B5D	Lever	WALL	22kA	
E106A. Comm/Res Alt Energy Sockets w/Main-250V Max						
120/240V 1PH 4-Terminal 200 Amp						
Eaton-CH						
	OH/UG	MBX2040PV200BTS	Lever	WALL	22kA	
120/208V 1PH 5-Terminal 200 Amp						
Siemens/Talon						
	OH/UG	MC2040S1200JLC	Lever	WALL	10kA	

Notes:

(17) Limited underground use only small & med. Conductor (4/0 is max. size UG allowed).

OH only sockets have been moved to a maintenance only section: E106M, E106AM & E106BM

Manufacturer	Use	Catalog Number	Bypass	Mount	SCCR	Notes
E106B. Commercial/Residential with Dual Lug Sockets - 250V Max						
120/240V 1PH 4-Terminal 300 Amp						
Milbank						
	UG	U1797-O-K3L-K2L-ALT	Lever	WALL	10kA	
	UG	U3000-O-K3L-K2L-ALT	Lever	WALL	10kA	
120/208V 3PH 7-Terminal 300 Amp						
Siemens/Talon						
	OH/UG	48707-82	Lever	WALL	10kA	
E106C. Communications Meter Disconnct Combo						
120/240V 1PH 4-Terminal 60 Amp						
Milbank						
	OH/UG	U6419KK	Horn	WALL	10kA	

Notes:

- (1) - () = (blank) Durham, (CH) Eaton-Cutler Hammer, (E) Eaton, (MEP) Midwest Electric Products or (SQD) Square-D
- (2) UHT, UGHT, UTH, UGTH, UT, USTS & UGT Series: * = Select desired bolt-on hub or top configuration
- (3) # = Multiple catalog numbers, approved for positions as shown next to catalog number
- (19) Requires separate mains be installed.



E106.

Pictured: U4031-O-2/150-K3

OH only sockets have been moved to a maintenance only section: E106M, E106AM & E106BM



E106B.

Pictured: 48707-82



E306C.

Pictured: Milbank U6421

ELECTRIC SERVICE EQUIPMENT

METER SOCKETS

Issued Jan 2024

Manufacturer	Use	Catalog Number	Bypass	Mount	SCCR	Notes
E107. Multi-position Residential: Horizontal (2-6 meters)						
120/240V 1PH-in, 1PH-out 4-Terminal 100 Amp						
Durham, Eaton-Cutler Hammer or Midwest Electric Products						
	OH/UG	UHT6R1131*(-) (6 position)	Horn	WALL	10kA	(1)(2)
Milbank						
	OH/UG	U590#-X-KK-K1 (2-6 position)	Horn	WALL	10kA	(3)
	OH/UG	U803#-XL-KK (2-6 position)	Horn	WALL	10kA	(3)(19)
Siemens/Talon						
	OH/UG	UA#311-[0P, 0PQG or 0PZA] (2-4 position)	Horn	WALL	10kA	(3)
120/240V 1PH-in, 1PH-out 4-Terminal 200 Amp						
Durham, Eaton-Cutler Hammer or Midwest Electric Products						
	OH/UG	UHT#R2332*(-) (2-3 position)	Horn	WALL	10kA	(1)(2)(3)(19)
	OH/UG	UHT4R2352*(-) (4 position)	Horn	WALL	10kA	(1)(2)(19)
	OH/UG	UHT#R2392*(-) (5-6 position)	Horn	WALL	10kA	(1)(2)(3)(19)
Milbank						
	OH/UG	U125#-X-KK-K1 (2-6 position)	Horn	WALL	10kA	(3)(19)
	OH/UG	U588#-X-KK-K1 (2-6 position)	Horn	WALL	22kA	(3)
Siemens/Talon						
	OH/UG	UA#717-[YPQG or YPZA] (2-3 position)	Horn	WALL	10kA	(3)(19)
	OH/UG	UA#719-[KP or YPZA] (4-6 position)	Horn	WALL	10kA	(3)(19)
120/208V 1PH-in, 1PH-out 5-Terminal 100 Amp						
Milbank						
	OH/UG	U8032-XL-KK-5T9 (2 position)	Horn	WALL	10kA	(19)
	OH/UG	U590#-X-KK-5T (2-6 position)	Horn	WALL	10kA	
Siemens/Talon						
	OH/UG	UA2311-0P(659-0121 Lugs) (2 position)	Horn	WALL	10kA	(19)
120/208V 1PH-in, 1PH-out 5-Terminal 200 Amp						
Durham, Eaton-Cutler Hammer or Midwest Electric Products						
	OH/UG	UGHT2R2332*(-) (2 position)	Horn	WALL	10kA	(1)(2)(19)
Milbank						
	OH/UG	U1252-X-KK-5T-K1 (2 position)	Horn	WALL	10kA	(19)
Siemens/Talon						
	OH/UG	UA2719-KP(659-0121 Lugs) (2 position)	Horn	WALL	10kA	(19)
	OH/UG	UA2717-[YP(659-0121-Lugs) or YPZA] (2 position)	Horn	WALL	10kA	(19)

NOTES:

- (1) -() = (blank) Durham, (CH) Eaton-Cutler Hammer, (E) Eaton, (MEP) Midwest Electric Products or (SQD) Square-D
- (2) UHT, UGHT, UTH, UGTH, UT, USTS & UGT Series: * = Select desired bolt-on hub or top configuration
- (3) # = Multiple catalog numbers, approved for positions as shown next to catalog number
- (19) Requires separate mains be installed.



Pictured: Milbank U588

Pictured: U1256-X-KK-K1



OH only sockets have been moved to a maintenance only section: E107M

ELECTRIC SERVICE EQUIPMENT

METER SOCKETS

Issued Jan 2024

Manufacturer	Use	Catalog Number	Bypass	Mount	SCCR	Notes
E108. Multi-position Commercial/Residential: Horizontal (2-6 meters)						
120/240V 1PH-in, 1PH-out 4-Terminal 200 Amp						
Durham, Eaton-Cutler Hammer or Midwest Electric Products						
	OH/UG	UT#H42353*-() (2-3 position)	Lever	WALL	10kA	(1)(2)(3)(19)
	OH/UG	UT#H42393*-() (4-6 position)	Lever	WALL	10kA	(1)(2)(3)(19)
Milbank						
	OH/UG	U597#-XT (2-6 position)	Lever	WALL	10kA	(3)
120/208V 1PH-in, 1PH-out 5-Terminal 100 Amp						
Durham, Eaton-Cutler Hammer or Midwest Electric Products						
	OH/UG	UGT2H4253*-() (2 position)	Lever	WALL	10kA	(1)(2)
120/208V 1PH-in, 1PH-out 5-Terminal 200 Amp						
Milbank						
	OH/UG	U2872-XT-5T9-K3 (2 position)	Lever	WALL	10kA	(19)
	OH/UG	U597#-XT-5T9 (2-6 position)	Lever	WALL	10kA	
Siemens/Talon						
	OH/UG	40405#-#23NU (2 position)	Lever	WALL	10kA	(4)(19)
120/208V 3PH-in, 3PH-out 7-Terminal 200 Amp						
Durham, Eaton-Cutler Hammer or Midwest Electric Products						
	OH/UG	UT#H72353*-() (2-3 position)	Lever	WALL	10kA	(1)(2)(3)(19)
	OH/UG	UT#H72393*-() (4-6 position)	Lever	WALL	10kA	(1)(2)(3)(19)
Milbank						
	OH/UG	U273#-XT-K7 (2-6 position)	Lever	WALL	10kA	(3)(19)
Siemens/Talon						
	OH/UG	40407#-#23NU (2-6 position)	Lever	WALL	10kA	(4)(17)(19)
E109. Multi-position Commercial/Residential: Vertical (2-6 meters)						
120/240V 1PH-in, 1PH-out 4-Terminal 200 Amp WPL ONLY						
Erickson Electric						
	UG	CM04#B# (2-3 position)	Lever	PANEL	10kA	(5)
120/208V 3PH-in, 3PH-out 7-Terminal 200 Amp WPL ONLY						
Erickson Electric						
	UG	CM07#B# (2-3 position)	Lever	PANEL	10kA	(5)

NOTES:

- (1) -() = (blank) Durham, (CH) Eaton-Cutler Hammer, (E) Eaton, (MEP) Midwest Electric Products or (SQD) Square-D
- (2) UHT, UGHT, UTH, UGTH, UT, USTS & UGT Series: * = Select desired bolt-on hub or top configuration
- (3) # = Multiple catalog numbers, approved for positions as shown next to catalog number
- (4) 4040 Series: 1st # = 2, 3, 4, 5 or 6 for number of positions, 2nd # = 0: for 2-3 position or 2: for 4-6 position; Must order 22k Breakers (Main UQFPH) & Series Kit 4714
- (5) CM0 Series: 1st # = Select number: 2 or 3 for number of positions, 2nd # = 5: 400A bus, 6: 600A bus
- (17) Limited underground use only small & med. Conductor (4/0 is max. size UG allowed).
- (19) Requires separate mains be installed.

Pictured: U5974-XT-5T9



OH only sockets have been moved to a maintenance only section: E109M





ELECTRIC SERVICE EQUIPMENT

METER SOCKETS

Issued Jan 2024

Manufacturer	Use	Catalog Number	Bypass	Mount	SCCR	Notes
E110. Residential All-in-one Meter Packs (2-6 meters)						
120/240V 1PH-in, 1PH-out 4-Terminal 200 Amp						
Eaton-CH						
	OH/UG	1MP#20#RRLB (2-5 Position) (WPL ONLY)	Horn	PANEL	10kA	(9)
GE						
	OH/UG	TMMR##20RHB (2-6 position) (WPL ONLY)	Horn	PANEL	10kA	(6)
Siemens/Talon						
	OH/UG	WPK##12RJB (2-6 position)	Horn	WALL	100kA	(7)
	OH/UG	WP##12RJB (2-6 position) (WPL ONLY)	Horn	WALL	100kA	(7)
	OH/UG	WPC4#12RJB (2-3 position) (WPL ONLY)	Horn	WALL	100kA	(3)
Square D						
	OH/UG	MPH##200 (2-6 position) (WPL ONLY)	Horn	PANEL	22kA	(8)
120/208V 1PH-in, 1PH-out 5-Terminal 100 Amp						
Eaton-CH						
	OH/UG	1MP#12#RRLB (2-6 Position) (WPL ONLY)	Horn	PANEL	10kA	(9)
GE						
	OH/UG	TMMR##12RHB (2-6 position) (WPL ONLY)	Horn	PANEL	10kA	(6)
Siemens/Talon						
	OH/UG	WPK##11RJB (2-6 position)	Horn	WALL	100kA	(7)
	OH/UG	WP##11RJB (2-6 position) (WPL ONLY)	Horn	WALL	100kA	(7)
120/208V 1PH-in, 1PH-out 5-Terminal 200 Amp						
Eaton-CH						
	OH/UG	1MP#20#RRLB (2 Position) (WPL ONLY)	Horn	PANEL	10kA	(9)
GE						
	OH/UG	TMMR##20RHB (2-6 position) (WPL ONLY)	Horn	PANEL	10kA	(6)
Siemens/Talon						
	OH/UG	WPK##12RJB (2-6 position)	Horn	WALL	100kA	(7)
	OH/UG	WP##12RJB (2-6 position) (WPL ONLY)	Horn	WALL	100kA	(7)
	OH/UG	WPC4#12RJB (2-3 position) (WPL ONLY)	Horn	WALL	100kA	(3)
Square D						
	OH/UG	MPH##200 (2-6 position) (WPL ONLY)	Horn	PANEL	22kA	(8)
120/240V 1PH-in, 1PH-out 4-Terminal 100 Amp						
GE						
	OH/UG	TMMR##12RHB (2-6 position) (WPL ONLY)	Horn	PANEL	10kA	(6)
Milbank						
	OH/UG	U285#-X-KK-K1 (2-6 position) (WPL ONLY)	Horn	WALL	10kA	(3)
Siemens/Talon						
	OH/UG	WPK##11RJB (2-6 position)	Horn	WALL	100kA	(7)
	OH/UG	WP##11RJB (2-6 position) (WPL ONLY)	Horn	WALL	100kA	(7)
E111. Commercial/Residential All-in-one Meter Packs (2-6 meters)						
120/240V 1PH-in, 1PH-out 4-Terminal 200 Amp						
Siemens/Talon						
	OH/UG	WPL#12RJ (2-6 position)(WPL ONLY)	Lever	PANEL	100kA	(3)
Square D						
	OH/UG	MPL53225 (3 position)(WPL ONLY)	Lever	PANEL	22kA	
120/208V 1PH-in, 1PH-out 5-Terminal 200 Amp						
Siemens/Talon						
	OH/UG	WPL#12RJ (2-6 position)(WPL ONLY)	Lever	WALL	100kA	(3)

NOTES:

- (3) # = Multiple catalog numbers, approved for positions as shown next to catalog number
- (6) TMMR Series: 1st # = 2: 200A bus, 4:400A bus, 6:600A bus, 2nd # = 2, 3, 4, 5 or 6 for number of positions
- (7) WP Series: 1st # = 2, 3, 4, 5 or 6 for bus amperage, 2nd # = 3, 4, 5 or 6 for number of positions
- (8) MPH Series: 1st # = bus: 2: 200A, 3:300A, 4:400A, 5:500A 6:600A, 8:800A; 2nd # = 2, 3, 4, 5 or 6 for positions
- (9) 1MP#12#RRLB: 1st # = 2, 3, 4, 5 or 6 for number of positions, 2nd # = 2: 200A bus, 4:400A bus, 6:600A bus

ELECTRIC SERVICE EQUIPMENT

METER SOCKETS

Issued Jan 2024

Manufacturer	Use	Catalog Number	Bypass	Mount	SCCR	Notes
E112. Residential Meter Pedestals - 250V Max						
120/240V 1PH 4-Terminal 200 Amp						
Durham, Eaton-Cutler Hammer, Midwest Electric Products, or Square-D						
	UG	1009264-() (2 position)	Horn	WALL	10kA	(1)
	UG	UHTRP242363-()	Horn	WALL	10kA	(1)
Milbank						
	UG	U1783-O-KK (2 position)	Horn	WALL	10kA	(10)
	UG	U3358-O-KK	Horn	WALL	30kA	(10)
Siemens/Talon						
	UG	UAP317-PP-WI	Horn	WALL	10kA	
	UG	UAP2317-PP-WI (2 position)	Horn	WALL	10kA	
120/208V 1PH 5-Terminal 200 Amp						
Durham, Eaton-Cutler Hammer or Midwest Electric Products						
	UG	UGHTRP242363-()	Horn	WALL	10kA	(1)
Milbank						
	UG	U1783-O-KK-K5T (2 position)	Horn	WALL	10kA	(10)
	UG	U3358-O-KK-K5T	Horn	WALL	30kA	(10)
E112A. Residential 320A Meter Pedestals - 250V Max						
120/240V 1PH 4-Terminal 320 Amp						
Milbank						
	UG	U1748-O-WI	Lever	WALL	22kA	

NOTES:

(1) -() = (blank) Durham, (CH) Eaton-Cutler Hammer, (E) Eaton, (MEP) Midwest Electric Products or (SQD) Square-D

(10) Extension Kit or Stabilizer Foot required for freestanding, direct buried, pad or post-mount. Contact manufacturer for details and part number.



E112.
Pictured: U3358-O-KK

ELECTRIC SERVICE EQUIPMENT

METER SOCKETS

Issued Jan 2024

Manufacturer	Use	Catalog Number	Bypass	Mount	SCCR	Notes
E113. Residential Meter Pedestals with Main - 250V Max						
120/240V 1PH 4-Terminal 100 Amp						
Durham, Eaton-Cutler Hammer or Midwest Electric Products						
	UG	1009843-() (note: utility on right side)	Horn	WALL	10kA	(1)
	UG	1009078-CH	Horn	WALL	10kA	(1)
Milbank						
	UG	U5925-O-100-KK	Horn	WALL	10kA	(10)
Siemens/Talon						
	UG	MP0406B1100RB	Horn	WALL	22kA	
120/240V 1PH 4-Terminal 150 Amp						
Milbank						
	UG	U5925-O-150-KK	Horn	WALL	10kA	(10)
120/240V 1PH 4-Terminal 200 Amp						
Durham, Eaton-Cutler Hammer or Midwest Electric Products						
	UG	1009842-() (note: utility on right side)	Horn	WALL	10kA	(1)
	UG	1008846-CH	Horn	WALL	10kA	(1)
Milbank						
	UG	U5925-O-200-KK	Horn	WALL	10kA	(10)
Siemens/Talon						
	UG	MP0406B1200RB	Horn	WALL	22kA	
120/208V 1PH 5-Terminal 100 Amp						
Siemens/Talon						
	UG	MP0406B1100RB	Horn	WALL	22kA	
120/208V 1PH 5-Terminal 200 Amp						
Siemens/Talon						
	UG	MP0406B1200RB	Horn	WALL	22kA	
E113A. Residential 320A Meter Pedestals with Main - 250V Max						
120/240V 1PH 4-Terminal 320 Amp						
Eaton-CH						
	UG	1009017-CH	Lever	WALL	22kA	(10)
Milbank						
	UG	U6318-O-2-200-K3L	Lever	WALL	22kA	(10)
	UG	U6317-O-2/200-K3L	Lever	WALL	22kA	(10)

NOTES:

(1) -() = (blank) Durham, (CH) Eaton-Cutler Hammer, (E) Eaton, (MEP) Midwest Electric Products or (SQD) Square-D

(10) Extension Kit or Stabilizer Foot required for freestanding, direct buried, pad or post-mount. Contact manufacturer for details and part number.



E113.
Pictured: U5925-O-200-KK

ELECTRIC SERVICE EQUIPMENT

METER SOCKETS

Issued Jan 2024

Manufacturer	Use	Catalog Number	Bypass	Mount	SCCR	Notes
E114. Commercial/Residential Meter Pedestals - 250V Max						
120/240V 1PH 4-Terminal 200 Amp						
Milbank						
	UG	U4724-O	Lever	WALL	10kA	
120/240V 1PH 4-Terminal 320 Amp						
Durham, Eaton-Cutler Hammer, Midwest Electric Products, or Square-D						
	UG	1009018-()	Lever	WALL	10kA	(1)(10)
Milbank						
	UG	U1748-O-WI	Lever	WALL	22kA	(10)
Siemens/Talon						
	UG	47604P-9WI	Lever	WALL	10kA	
120/208V 1PH 5-Terminal 200 Amp						
Milbank						
	UG	U4724-O-5T9	Lever	WALL	10kA	
Siemens/Talon						
	UG	40405P-9WI	Lever	WALL	10kA	
120/208V 1PH 5-Terminal 300 Amp						
Milbank						
	UG	U1748-O-5T9-WI	Lever	WALL	22kA	(10)
120/208V 3PH 7-Terminal 200 Amp						
Durham, Eaton-Cutler Hammer or Midwest Electric Products						
	UG	1009846-()	Lever	WALL	10kA	(1)
Milbank						
	UG	U9107-O-WI	Lever	WALL	10kA	(10)
Siemens/Talon						
	UG	40407P-9WI	Lever	WALL	10kA	(17)

NOTES:

- (1) -() = (blank) Durham, (CH) Eaton-Cutler Hammer, (E) Eaton, (MEP) Midwest Electric Products or (SQD) Square-D
- (10) Extension Kit or Stabilizer Foot required for freestanding, direct buried, pad or post-mount. Contact manufacturer for details and part number.
- (17) Limited underground use only small & med. Conductor (4/0 is max. size UG allowed).



Pictured: U4724-O-5T9

ELECTRIC SERVICE EQUIPMENT

METER SOCKETS

Issued Jan 2024

Manufacturer	Use	Catalog Number	Bypass	Mount	SCCR	Notes
E115. Commercial/Residential Meter Pedestals with Main - 250V Max						
120/240V 1PH 4-Terminal 100 Amp						
Milbank						
	UG	U4322-O-100MB	Lever	POST	10kA	(10)
	UG	U4323-O-100MB (2 position)	Lever	POST	10kA	(10)
	UG	U5701-O-100S	Lever	POST	10kA	(10)
	UG	U6221-O-100-10GR	Lever	POST	22kA	(10)
	UG	CP3*511***	Lever	PAD	22kA	(11)
Tesco						
	UG	26-000 or 27-000	Lever	PAD	10kA	(12)
Giese						
	UG	DBQ2832-66	Lever	PAD	10kA	(21)
120/240V 1PH 4-Terminal 200 Amp						
Midwest Electric						
	UG	R281E1P6H034	Lever	POST	10kA	
	UG	R281C1P6H034	Lever	POST	10kA	
	UG	R281C1B6H034 (2 position)	Lever	POST	10kA	
Milbank						
	UG	U5701-O-200S	Lever	POST	10kA	(10)
	UG	U6221-O-200-10GR	Lever	POST	22kA	(10)
	UG	CP3*521***	Lever	PAD	22kA	(11)
Tesco						
	UG	26-000 or 27-000	Lever	PAD	10kA	(12)
Giese						
	UG	DBQ2832-66	Lever	PAD	10kA	(21)
120/240V 1PH 4-Terminal 300 Amp						
Eaton-CH						
	UG	1009020	Lever	WALL	22kA	(10)
Durham, Eaton-Cutler Hammer or Midwest Electric Products						
	UG	1009841-()	Lever	WALL	22kA	(1)
	UG	1009565-()	Lever	WALL	22kA	(1)
Milbank						
	UG	CP3*541***	Lever	PAD	22kA	(11)
	UG	U6318-O-2-150-K3L	Lever	WALL	22kA	(10)
	UG	U6318-O-200-100-K3L	Lever	WALL	22kA	(10)
	UG	U6317-O-200-100-K3L	Lever	WALL	22kA	(10)
	UG	U6317-O-2/150-K3L	Lever	WALL	22kA	(10)
Tesco						
	UG	26-000 or 27-000	Lever	PAD	10kA	(12)
Giese						
	UG	DBQ2832-66	Lever	PAD	10kA	(21)

NOTES:

- (1) -() = (blank) Durham, (CH) Eaton-Cutler Hammer, (E) Eaton, (MEP) Midwest Electric Products or (SQD) Square-D
- (10) Extension Kit or Stabilizer Foot required for freestanding, direct buried, pad or post-mount. Contact manufacturer for details and part number.
- (11) CP3 Series: * = Both "A" and "B" approved, *** = Remainder of part number is customizable to specific installation
- (21) Giese Cabinet: Approved for use only with U5871-XL-200 meter socket

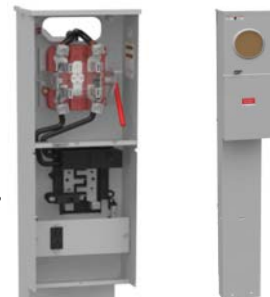

Pictured: U6221-O-200-10GR

ELECTRIC SERVICE EQUIPMENT

METER SOCKETS

Issued Jan 2024

Manufacturer	Use	Catalog Number	Bypass	Mount	SCCR	Notes
E115. Commercial/Residential Meter Pedestals with Main - 250V Max (continued)						
120/208V 1PH 5-Terminal 100 Amp						
Milbank						
	UG	U4322-O-100MB-K3865	Lever	POST	10kA	(10)
	UG	U4323-O-100MB-K3865 (2 position)	Lever	POST	10kA	(10)
Tesco						
	UG	26-000 or 27-000	Lever	PAD	10kA	(12)
120/208V 1PH 5-Terminal 200 Amp						
Milbank						
	UG	U4833-0-5T9	Lever	WALL	22kA	
Siemens/Talon						
	UG	MP0406B1200RJL-MPEXT	Lever	POST	10kA	
	UG	MP0606L1200RJL-MPEXT	Lever	POST	10kA	
Tesco						
	UG	26-000 or 27-000	Lever	PAD	10kA	(12)
120/208V 3PH 7-Terminal 100 Amp						
Milbank						
	UG	CP3*515***	Lever	PAD	22kA	(11)
Tesco						
	UG	26-000 or 27-000	Lever	PAD	10kA	(12)
120/208V 3PH 7-Terminal 200 Amp						
Milbank						
	UG	CP3*525***	Lever	PAD	22kA	(11)
Tesco						
	UG	26-000 or 27-000	Lever	PAD	10kA	(12)
120/208V 3PH 7-Terminal 300 Amp						
Milbank						
	UG	CP3*545***	Lever	PAD	22kA	(11)
Tesco						
	UG	26-000 or 27-000	Lever	PAD	10kA	(12)

NOTES:

- (10) Extension Kit or Stabilizer Foot required for freestanding, direct buried, pad or post-mount. Contact manufacturer for details and part number.
- (11) CP3 Series: * = Both "A" and "B" approved, *** = Remainder of part number is customizable to specific installation
- (12) Tesco Pedestal: Approved for use only with an approved meter socket listed in ESE Chapter 1



Pictured: MP0606L1200RJL-MPEXT

ELECTRIC SERVICE EQUIPMENT

METER SOCKETS

Issued Jan 2024

Manufacturer	Use	Catalog Number	Bypass	Mount	SCCR	Notes
E116. Manufactured Home Meter Pedestals with Main - 250V Max						
120/240V 1PH 4-Terminal 100 Amp						
Midwest Electric						
	UG	R101CB6HP (2 position)	Horn	POST	10kA	
	UG	R101CP6HP (1 position)	Horn	POST	10kA	
Milbank						
	UG	U5136-O-100S-ALT (1 position)	Horn	POST	10kA	(10)(13)
	UG	U5137-O-100S-ALT (2 position)	Horn	POST	10kA	(10)(13)
	UG	U5702-O-100S (2 position)	Lever	POST	22kA	(10)
Siemens/Talon						
	UG	MP0406B1100R-MPEXT	Horn	POST	10kA	
120/240V 1PH 4-Terminal 200 Amp						
Midwest Electric						
	UG	R281C1B6H (2 position)	Horn	POST	10kA	
	UG	R281C1P6H (1 position)	Horn	POST	10kA	
Milbank						
	UG	U5136-O-200S-ALT (1 position)	Horn	POST	22kA	(10)(13)
	UG	U5137-O-200S-ALT (2 position)	Horn	POST	22kA	(10)(13)
	UG	U5702-O-200S (2 position)	Lever	POST	22kA	(10)
Siemens/Talon						
	UG	MP0406B1200R-MPEXT	Horn	POST	10kA	
E117. Recreational Vehicle Meter Pedestals with Main - 250V Max						
120/240V 1PH 4-Terminal 100 Amp						
Milbank						
	UG	U5136-O-100S-ALT (1 position)	Horn	POST	10kA	(10)
	UG	U5137-O-100S-ALT (2 position)	Horn	POST	10kA	(10)
120/240V 1PH 4-Terminal 200 Amp						
Milbank						
	UG	U5136-O-200S-ALT (1 position)	Horn	POST	22kA	(10)
	UG	U5137-O-200S-ALT (2 position)	Horn	POST	22kA	(10)

NOTES:

(10) Extension Kit or Stabilizer Foot required for freestanding, direct buried, pad or post-mount. Contact manufacturer for details and part number.

(13) Specify Milbank Series K5400-Bridge-(XXX) receptacle/circuit breaker kits as needed for manufactured home power supply cord or other convenience receptacle



Pictured: U5136-O-200S-ALT-K5415

ELECTRIC SERVICE EQUIPMENT

METER SOCKETS

Issued Jan 2024

Manufacturer	Use	Catalog Number	Bypass	Mount	SCCR	Notes
E118. Temporary Residential Only Equipment 120/240V Single-Phase						
120/240V 1PH 4-Terminal 100 Amp						
Midwest Electric						
	UG	R111CB2010	Horn	WALL	10kA	(16)
	UG	R138CB2033	Horn	WALL	10kA	(17)
	UG	R176CB2033	Horn	WALL	10kA	(18)
Milbank						
	UG	U4908-O-100MB-KK-11GR	Horn	WALL	10kA	
	UG	U4908-O-100MB-KK-76GBGR	Horn	WALL	10kA	
Siemens/Talon						
	UG	TL***H2M	Horn	PAD	10kA	(14)
	UG	TL***H2P	Horn	POST	10kA	(14)
	UG	TL***HB	Horn	WALL	10kA	(14)
	UG	TL***HM	Horn	PAD	10kA	(14)
	UG	TL***HP	Horn	POST	10kA	(14)
	UG	TD137HB	Horn	POST	10kA	(14)
E119. Temporary Commercial/Residential Equipment 120/240V or 120/208V 1PH						

NOTES:

- (14) T-Series: *** = Choose Receptacle Options to meet project needs
- (16) (2) 5-20WR GFCI
- (17) (2) 5-20WR GFCI (1) 6-20R
- (18) (2) 5-20WR GFCI (1) 14-50WR

OH only sockets have been moved to a maintenance only section: E118M & E119M

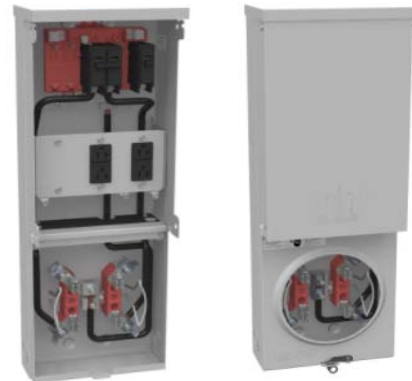

Pictured: U4908-O-KK-11GR



ELECTRIC SERVICE EQUIPMENT

METER SOCKETS

Issued Jan 2024

Manufacturer	Use	Catalog Number	Bypass	Mount	SCCR	Notes
E101M. Res Sockets - 250V Max IA OH (WI MAINTENANCE ONLY)						
120/240V 1PH 4-Terminal 100 Amp						
Durham, Eaton-Cutler Hammer, Midwest Electric Products, or Square-D						
	OH	UHTRS101*-()	Horn	WALL	10kA	(1)(2)
	OH	UHTRS111*-()	Horn	WALL	10kA	(1)(2)
Milbank						
	OH	U7487-RL-TG-KK-ALT	Horn	WALL	10kA	
Siemens/Talon						
	OH	UAT111-0MSP	Horn	WALL	10kA	
120/240V 1PH 4-Terminal 200 Amp						
Durham, Eaton-Cutler Hammer, Midwest Electric Products, or Square-D						
	OH	UHTRS202*-()	Horn	WALL	10kA	(1)(2)
	OH	UHTRS213*-()	Horn	WALL	10kA	(1)(2)
	OH	UHTRS213BE	Horn	WALL	10kA	(1)
Milbank						
	OH	U1773-XL-TG-KK	Horn	WALL	10kA	
	OH	U7040-XL-TG-KK-ALT	Horn	WALL	10kA	
	OH	U7043-XL-TG-KK-ALT	Horn	WALL	10kA	
	OH	U3850-XL-QG-KK-ALT	Horn	WALL	10kA	
Siemens/Talon						
	OH	UAT317-[DPQG, DVZ, OPQG, XP or OPGP]	Horn	WALL	10kA	
	OH	UAT417-[OPQG, XP or XPQG]	Horn	WALL	10kA	(18)
120/208V 1PH 5-Terminal 100 Amp						
Durham, Eaton-Cutler Hammer, Midwest Electric Products, or Square-D						
	OH	UGHTRS101*-()	Horn	WALL	10kA	(1)(2)
	OH	UGHTRS111*-()	Horn	WALL	10kA	(1)(2)
Milbank						
	OH	U7487-RL-TG-KK-5T	Horn	WALL	10kA	
Siemens/Talon						
	OH	UAT111-OP(659-0121-Lugs)]	Horn	WALL	10kA	
120/208V 1PH 5-Terminal 200 Amp						
Durham, Eaton-Cutler Hammer or Midwest Electric Products						
	OH	UGHTRS202*-()	Horn	WALL	10kA	(1)(2)
	OH	UGHTRS213*-()	Horn	WALL	10kA	(1)(2)
Milbank						
	OH	U1773-XL-TG-KK-5T	Horn	WALL	10kA	
	OH	U7040-XL-TG-KK-5T	Horn	WALL	10kA	
	OH	U3850-XL-QG-KK-5T	Horn	WALL	10kA	
Siemens/Talon						
	OH	UAT317-[0MSP or OP(659-0121-Lugs)]	Horn	WALL	10kA	
	OH	UAT417-[XP(659-0121-Lugs) or XVZ]	Horn	WALL	10kA	(18)

NOTES:

- (1) -() = (blank) Durham, (CH) Eaton-Cutler Hammer, (E) Eaton, (MEP) Midwest Electric Products or (SQD) Square-D
- (2) UHT, UGHT, UTH, UGTH, UT, USTS & UGT Series: * = Select desired bolt-on hub or top configuration
- (18) Limited underground use only small conductor only (1/0 is max. size UG allowed).



ELECTRIC SERVICE EQUIPMENT

METER SOCKETS

Issued Jan 2024

Manufacturer	Use	Catalog Number	Bypass	Mount	SCCR	Notes
E102M. Res Sockets W/ Main & Panel - 250V Max IA OH (WI MAINT ONLY)						
120/240V 1PH 4-Terminal 100 Amp						
Milbank						
	OH	U7375-RL-100-TG-KK	Horn	WALL	10kA	
120/240V 1PH 4-Terminal 150 Amp						
Milbank						
	OH	U5268-XTL-150-KK	Horn	WALL	22kA	
120/240V 1PH 4-Terminal 200 Amp						
Midwest Electric						
	OH	RS251C	Horn	WALL	10kA	
Milbank						
	OH	U5268-XTL-200-KK	Horn	WALL	22kA	
Siemens/Talon						
	OH	UAB317-OPCH	Horn	WALL	10kA	
Ronk						
	OH	MSB200H	Horn	WALL	22kA	



ELECTRIC SERVICE EQUIPMENT

METER SOCKETS

Issued Jan 2024

Manufacturer	Use	Catalog Number	Bypass	Mount	SCCR	Notes
E103M. Comm/Res Sockets - 250V Max IA OH (WI MAINTENANCE ONLY)						
120/240V 1PH 4-Terminal 200 Amp						
Durham, Eaton-Cutler Hammer, Midwest Electric Products, or Square-D						
	OH	UTH4203*-()	Lever	WALL	10kA	(1)(2)
	OH	UTH4213*-()	Lever	WALL	10kA	(1)(2)
Milbank						
	OH	U4801-XL-ALT	Lever	WALL	10kA	(17)
	OH	U9800-RRL	Lever	WALL	10kA	
	OH	U9865-[RRL-K1-ALT or RXL-2/K1-ALT]	Lever	WALL	10kA	
Siemens/Talon						
	OH	40404-02QG	Lever	WALL	10kA	
	OH	40804-01QG	Lever	WALL	10kA	
120/240V 1PH 4-Terminal 300 Amp						
Durham, Eaton-Cutler Hammer, Midwest Electric Products, or Square-D						
	OH	1008539-()	Lever	WALL	10kA	(1)
Milbank						
	OH	U1779-RRL-K3-K2-ALT	Lever	WALL	10kA	
Siemens/Talon						
	OH	47604-82	Lever	WALL	10kA	
120/208V 1PH 5-Terminal 200 Amp						
Durham, Eaton-Cutler Hammer or Midwest Electric Products						
	OH	UGTH4203*-()	Lever	WALL	10kA	(1)(2)
	OH	UGTH4213*-()	Lever	WALL	10kA	(1)(2)
Milbank						
	OH	U4801-XL-5T9	Lever	WALL	10kA	(17)
	OH	U9800-RRL-5T9	Lever	WALL	10kA	
	OH	U9865-[RRL-K1-5T9-ALT or RXL-2/K1-5T9-ALT]	Lever	WALL	10kA	
Siemens/Talon						
	OH	40405-02CO	Lever	WALL	10kA	
120/208V 3PH 7-Terminal 200 Amp						
Durham, Eaton-Cutler Hammer or Midwest Electric Products						
	OH	UTH7203*-()	Lever	WALL	10kA	(1)(2)
Milbank						
	OH	U9700-RRL	Lever	WALL	10kA	
Siemens/Talon						
	OH	40007-[01 or 01QG]	Lever	WALL	10kA	
	OH	40407-[015, 01NU, 025, 02CO or 02QG]	Lever	WALL	10kA	(17)
120/208V 3PH 7-Terminal 300 Amp						
Durham, Eaton-Cutler Hammer, Midwest Electric Products, or Square-D						
	OH	1008542-()	Lever	WALL	10kA	(1)
Siemens/Talon						
	OH	44707-02PP	Lever	WALL	10kA	

NOTES:

- (1) -() = (blank) Durham, (CH) Eaton-Cutler Hammer, (E) Eaton, (MEP) Midwest Electric Products or (SQD) Square-D
- (2) UHT, UGHT, UTH, UGTH, UT, USTS & UGT Series: * = Select desired bolt-on hub or top configuration
- (17) Limited underground use only small & med. Conductor (4/0 is max. size UG allowed).



ELECTRIC SERVICE EQUIPMENT

METER SOCKETS

Issued Jan 2024

Manufacturer	Use	Catalog Number	Bypass	Mount	SCCR	Notes
E104AM. Comm/Res Sockets - 480V Max IA OH (WI MAINTENANCE ONLY)						
277/480V 3PH 7-Terminal 200 Amp						
Durham, Eaton-Cutler Hammer, Midwest Electric Products, or Square-D						
	OH	UTH7213-()	Lever	WALL	10kA	(1)
Milbank						
	OH	U9701-RXL-ALT	Lever	WALL	10kA	(17)
E104BM. Comm/Res Sockets - 480V Max IA OH (WI MAINTENANCE ONLY)						
277/480V 3PH 7-Terminal 60 Amp						
A.M.P.						
	OH	ALISESMHC60	Lever	WALL	10kA	(15)
277/480V 3PH 7-Terminal 100 Amp						
A.M.P.						
	OH	ALISESMHC100	Lever	WALL	10kA	(15)
277/480V 3PH 7-Terminal 200 Amp						
A.M.P.						
	OH	ALISESMHC200	Lever	WALL	10kA	(15)
E105M. Comm/Res Instrument TRF Rated Sockets IA OH (WI MAINTENANCE ONLY)						
1PH 8-Terminal 20 Amp MAINTENANCE ONLY IPL						
Durham, Eaton-Cutler Hammer or Midwest Electric Products						
	OH/UG	USTS82B165-() (IP&L)	Test Sw.	WALL	10kA	(1)
	OH/UG	USTS82B166-() (IP&L)	Test Sw.	WALL	10kA	(1)
Milbank						
	OH/UG	UC7448-RL-351 (IP&L)	Test Sw.	WALL	10kA	
	OH/UG	UC7448-XL-341 (IP&L)	Test Sw.	WALL	10kA	
Siemens/Talon						
	OH/UG	9837-0930(IP&L)	Test Sw.	WALL	10kA	
	OH/UG	9837-0931(IP&L)	Test Sw.	WALL	10kA	
1PH 8-Terminal 20 Amp MAINTENANCE ONLY WPL						
Durham, Eaton-Cutler Hammer or Midwest Electric Products						
	OH/UG	USTS82B-() (WP&L)	Test Sw.	WALL	10kA	(1)
Milbank						
	OH/UG	UC7448-XL (WP&L)	Test Sw.	WALL	10kA	
Siemens/Talon						
	OH/UG	9837-8403(WP&L)	Test Sw.	WALL	10kA	

NOTES:

- (1) -() = (blank) Durham, (CH) Eaton-Cutler Hammer, (E) Eaton, (MEP) Midwest Electric Products or (SQD) Square-D
- (15) Combination non-fused cold sequence disconnect, 200A 3Ph self-contained socket
- (17) Limited underground use only small & med. Conductor (4/0 is max. size UG allowed).



ELECTRIC SERVICE EQUIPMENT

METER SOCKETS

Issued Jan 2024

Manufacturer	Use	Catalog Number	Bypass	Mount	SCCR	Notes
E106M. Comm/Res Sockets w/Main - 250V Max IA OH (WI MAINTENANCE ONLY)						
120/240V 1PH 4-Terminal 100 Amp						
Milbank						
	OH	U5871-XL-100	Lever	WALL	22kA	
	OH	U6012-XL-100-K1	Lever	WALL	22kA	
Siemens/Talon						
	OH	MC1224B1125JLC	Lever	WALL	10kA	
	OH	MM0202B1100RLC	Lever	WALL	10kA	
120/240V 1PH 4-Terminal 200 Amp						
Midwest Electric						
	OH	R208CR2A034	Lever	WALL	10kA	
Milbank						
	OH	U5871-XL-200	Lever	WALL	22kA	
	OH	U6281-XL-200-ALT	Lever	WALL	22kA	
Ronk						
	OH	MSB200L	Lever	WALL	22kA	
Siemens/Talon						
	OH	MC0816B1200JLT	Lever	WALL	22kA	
	OH	MC1224B1200JLC	Lever	WALL	10kA	
	OH	MC2040B1200JLC	Lever	WALL	10kA	
	OH	MC3042B1200JLC	Lever	WALL	10kA	
120/208V 1PH 5-Terminal 100 Amp						
Siemens/Talon						
	OH	MC16B1100RJB	Lever	WALL	10kA	
120/208V 1PH 5-Terminal 200 Amp						
Milbank						
	OH	U6281-XL-200-5T9-ALT	Lever	WALL	22kA	
120/240V 1PH 4-Terminal 150 Amp						
Siemens/Talon						
	OH	MC0816B1150JLT	Lever	WALL	10kA	
	OH	MC2040B1150JLC	Lever	WALL	10kA	
E106BM. Comm/Res w/Dual Lug Sockets - 250V Max IA OH (WI MAINTENANCE ONLY)						
120/240V 1PH 4-Terminal 300 Amp						
Milbank						
	OH	U1779-RRL-K3-K2-ALT	Lever	WALL	10kA	



ELECTRIC SERVICE EQUIPMENT

METER SOCKETS

Issued Jan 2024

Manufacturer	Use	Catalog Number	Bypass	Mount	SCCR	Notes
E107M. Multi-position Res: Horizontal (2-6 meters) IA OH (WI MAINTENANCE ONLY)						
120/240V 1PH-in, 1PH-out 4-Terminal 100 Amp						
Milbank						
	OH	U736#-RL-KK (2-6 position)	Horn	WALL	10kA	(3)
	OH/UG	L57#-XL-KK (2-6 position)	Horn	WALL	10kA	(3)
120/208V 1PH-in, 1PH-out 5-Terminal 100 Amp						
Milbank						
	OH	U7362-RL-KK-5T9 (2 position)	Horn	WALL	10kA	
E109M. Multi-position Comm/Res: Vertical (2-6 meters) IA OH (WI MAINTENANCE ONLY)						
120/240V 1PH-in, 1PH-out 4-Terminal 200 Amp						
Erickson Electric						
	OH	CM04#T# (2-3 position)	Lever	PANEL	10kA	(5)
120/208V 3PH-in, 3PH-out 7-Terminal 200 Amp						
Erickson Electric						
	OH	CM07#T# (2-3 position)	Lever	PANEL	10kA	(5)
E110M. Res All-in-one Meter Packs (2-6 meters) IA OH (WI MAINTENANCE ONLY)						
120/240V 1PH-in, 1PH-out 4-Terminal 100 Amp						
Siemens/Talon						
	OH	WPC2211RJB (2 position)	Horn	WALL	65kA	
Square D						
	OH	MPH##125 (2-6 position)	Horn	PANEL	42kA	(8)
120/208V 1PH-in, 1PH-out 5-Terminal 100 Amp						
Siemens/Talon						
	OH	WPC2211RJB (2 position)	Horn	WALL	65kA	
Square D						
	OH	MPH##125 (2-6 position)	Horn	PANEL	42kA	(8)
E118M. Temp Res Only Equipment 120/240V Single-Phase IA OH (WI MAINTENANCE ONLY)						
120/240V 1PH 4-Terminal 100 Amp						
Eaton-CH						
	OH	CHR#*##*#*S	Horn	WALL	10kA	(16)
Milbank						
	OH	U5101-RL-100MB-KK-76GBGR	Horn	WALL	10kA	
	OH	U5101-100MB-KK-11GR	Horn	WALL	10kA	
Siemens/Talon						
	OH	TL***HT	Horn	WALL	10kA	(14)
E119M. Temp Comm/Res Equipment 120/240V or 120/208V 1PH IA OH (WI MAINT ONLY)						
120/240V 1PH 4-Terminal 100 Amp						
Siemens/Talon						
	OH	TL***LT	Lever	WALL	10kA	(14)

NOTES:

- (8) MPH Series: 1st # = bus: 2: 200A, 3:300A, 4:400A, 5:500A 6:600A, 8:800A; 2nd # = 2, 3, 4, 5 or 6 for positions
- (14) T-Series: *** = Choose Receptacle Options to meet project needs
- (16) CHR: # = 1-7 receptacle selection, * = N/G breaker selection



ELECTRIC SERVICE EQUIPMENT

METER CABINETS

Issued Jan 2024

CHAPTER 2

ELECTRIC SERVICE EQUIPMENT – METER CABINETS

E200. TECHNICAL SPECIFICATIONS FOR METERING TRANSFORMER CABINETS AND CONDUCTOR TERMINATION BOXES

A. ACCEPTANCE

1. Only metering transformer cabinets and conductor termination boxes listed in this e-manual are acceptable for use in Alliant Energy service territories.
2. Metering transformer cabinets (sometimes referred to as CT Cabinets) shall be listed by an independent testing laboratory (such as UL 414 for Metering Transformer Cabinets) and labeled as “Metering Transformer Cabinets”.
3. Conductor termination boxes or cabinets shall be listed and labeled as “Termination Boxes or Cabinets” by an independent testing laboratory (such as UL 1773 for Termination Boxes).
4. Equipment installed, which has not been approved for use by Alliant Energy, will not be accepted. In order to assure interconnection, please utilize the equipment listed in the equipment section for the application shown.
5. All cabinets shall be inspected and approved by Alliant Energy to ensure they meet our requirements. Alliant Energy will not approve the use of altered, rusted, damaged or modified equipment.
6. It is not permitted to modify or install lugs larger than the meter socket or metering transformer cabinet is rated to accommodate per UL Listing.
7. The complete catalog number, as shown in the ESE e-manual, shall be included as part of the equipment nameplate.

B. SPECIFICATIONS / REQUIREMENTS

1. ENCLOSURE TYPE

As a minimum requirement, the cabinet type shall carry a NEMA 3R rating. For installations in a corrosive environment the cabinet shall carry NEMA 4X rating.

2. DOORS

Metering transformer cabinets and conductor termination boxes are to have side-hinged doors with a two or three-point handle operated locking device with a minimum 7/16 inch diameter sealing hole to accept a company pad-lock with a 3/8 inch shackle. The handle may not be operated when the lock is in place. The door(s) shall have a lockable wind-stop assembly installed. Wind stops shall be designed without the possibility of coming in contact with energized equipment.

ELECTRIC SERVICE EQUIPMENT**METER CABINETS**

Issued Jan 2024

3. BUS/LINE SIDE LUG SPECIFICATIONS

Line side lugs shall be of the Allen-Set screw type, suitable for aluminum conductors. All lugs in termination cabinets shall be either lay-in or Allen-Set screw type.

4. FASTENERS

All fasteners shall be captive hardware. No fasteners shall be able to be removed from the exterior of the cabinet. The only way to remove a fastener is by unlocking the door and gaining access to the inside of the cabinet.

5. ELECTRICAL CLEARANCES

Clearances per the *National Electrical Safety Code* and Wisconsin Electrical Code, Volume 1 (PSC 114), shall be maintained with instrument transformers and associated wiring installed and the cover(s) closed. The Alliant Energy minimum “H”, minimum depth and minimum width dimensions shall be maintained according to the Cabinet Specification Tables.

6. CURRENT TRANSFORMER (CT) MOUNTING

Bar style CT's shall be mounted vertically on factory installed cabinet bus bars. The CT shall be bolted to a landing pad such that the conductors cannot be bolted directly to the CT's.

7. POTENTIAL TRANSFORMER (PT) MOUNTING

PT'S shall not be mounted directly in front or behind any other electrical components or utility conductors. An external, side attached PT box may be used and must have the minimum dimensions of 8” wide, 23” high, and 8” in depth.

8. GROUNDING & BONDING

Grounding and bonding of some cabinet installations and bonding conductor sizes are shown in ESR e-manual Chapter 14.

C. ACCEPTABLE VOLTAGES AND CURRENT RANGES

See [ESR e-manual 108](#).

D. SERVICE CONFIGURATION

See [ESR e-manual 613.H](#).

E. CT BAR REQUIREMENTS

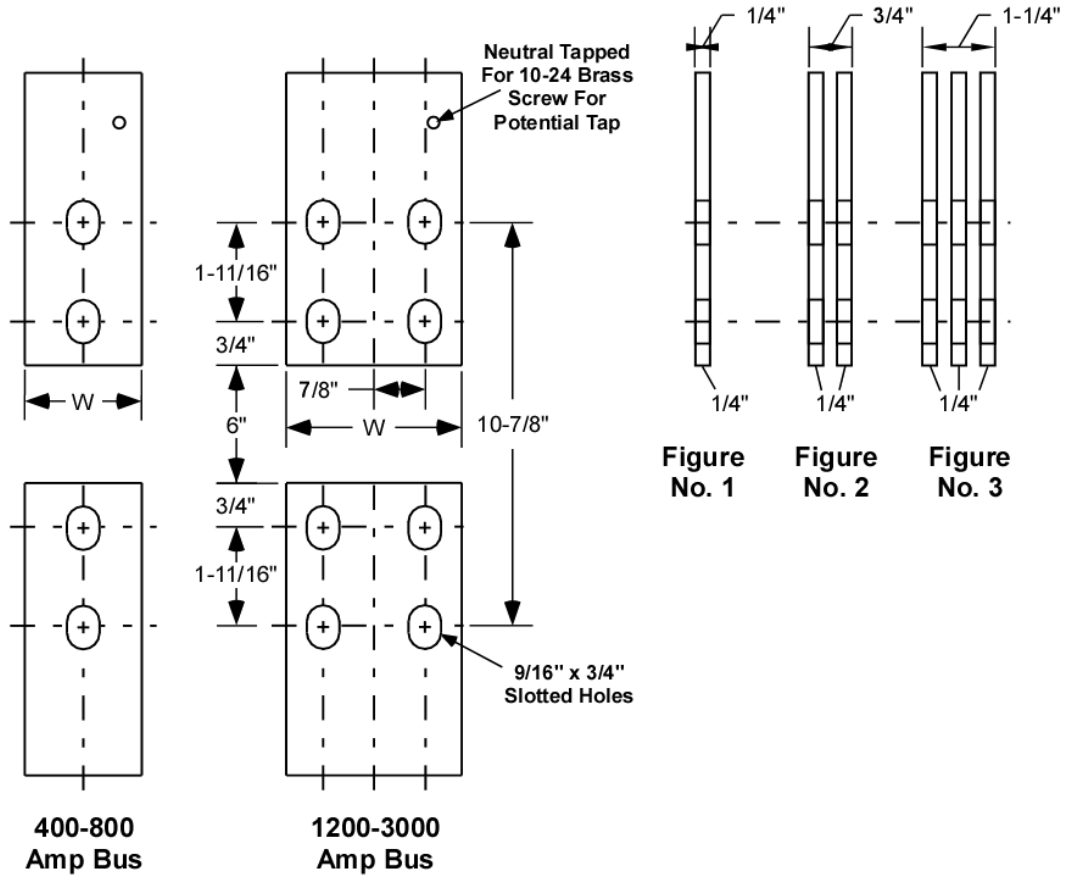

ESE200E.cvx

Amps	W	#/PH	Bars On Transformer	Figure No.	Mounting Bolt Size**
400	2-1/2	1	1	1	1/2 x 1-1/2
600	2-1/2	1	1	1	1/2 x 1-1/2
800	3	1	1	1	1/2 x 1-1/2
1200	3	1	1	1	1/2 x 1-1/2
1600	3	2	2*	2	1/2 x 2-1/2
2000	3	2	2	2	1/2 x 2-1/2
3000	3	3	3	3	1/2 x 2-1/2

* A single bar with adequate current capacity may be substituted.

** Customer shall furnish 1/2 mounting bolts for CT's

ELECTRIC SERVICE EQUIPMENT

METER CABINETS

Issued Jan 2024

F. CABLE SPACE REQUIREMENTS & CABINET SPECIFICATIONS

1. WALL-MOUNTED CABINETS (400A to 1200A)

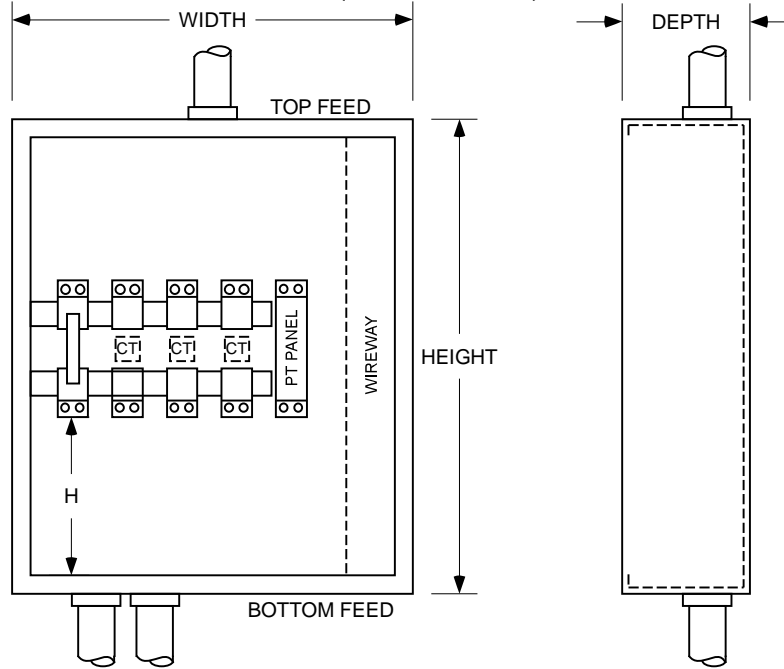

2. PAD-MOUNTED CABINETS (400A to 3000A)

All stand-alone non-bussed pad-mounted service equipment cabinets are designed for Bottom Entry and Bottom Exit.

“H” dimension refers to the distance from the bottom of the line side lug(s) to the bottom of the enclosure.

Entry or exit thru either the top or side is not acceptable.*

* Some cabinets are designed to be mounted against building or structure that may be allowed to exit the top or side. Contact Alliant Energy for approval before ordering and installing one of these cabinets.

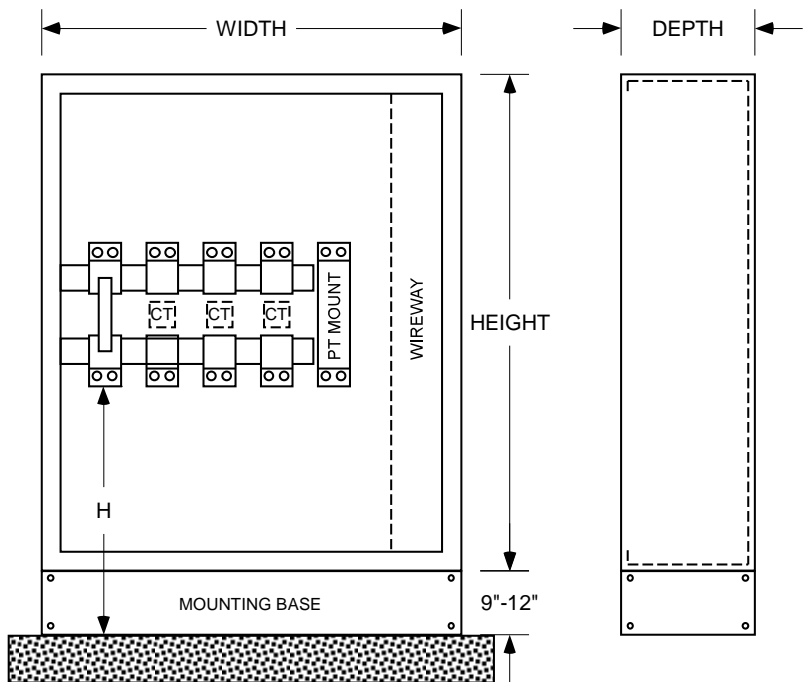



3. RESIDENTIAL METERING TRANSFORMER CABINET SPECIFICATIONS

- Wall Mount
- Bottom Entry / Top Exit
- Top Entry / Bottom Exit
- 250 Volts Maximum

Table 1:

Ampacity	Lugs per Phase	Lug Size	Conduit Size	Number of Conduits	Unprotected Fault Current Rating (Amps)	Minimum Width (Inches)	Minimum Depth (Inches)	Minimum "H" Dimension (Inches)
400	2	4/0-500	4"	2	42,000	20	8	14
600	2	4/0-500	4"	2	42,000	24	8	14

4. METERING TRANSFORMER CABINET SPECIFICATIONS - 250V Maximum

- Wall Mount (400A to 1200A) or Pad Mount (400A to 3000A)
- Bottom Entry / Top Exit
- Top Entry / Bottom Exit
- Bottom Entry / Bottom Exit
- 250 Volts Maximum

Table 2:

Ampacity	Lugs per Phase	Lug Size	Conduit Size	Number of Conduits	Unprotected Fault Current Rating (Amps)	Minimum Width (Inches)	Minimum Depth (Inches)	Minimum "H" Dimension (Inches)	
								Wall	*Pad
400	2	4/0-500	4"	2	42,000	20	11	20	20
600	2	4/0-500	4"	2	42,000	24	15	20	20
800	3	4/0-500	4"	3	42,000	24	15	20	20
1200	5	4/0-500	4"	5	65,000	34	15	20	20
1600	4	500-1000	5"	4	65,000	38	15	n/a	35
2000	5	500-1000	5"	5	65,000	38	15	n/a	35
2500	7	500-1000	5"	7	65,000	42	21	n/a	35
3000	8	500-1000	5"	8	65,000	42	21	n/a	35

Table Notes:

- Minimum criteria shown and may be exceeded to utilize manufacturer’s available equipment.
- See [drawings in E200.F. 1 & 2](#) for “H” dimension.
- * For pad mounted cabinets the 9” to 12” mounting base requirement is in addition to the required “H” dimension for cabinets 1600 amps or larger. 26” “H” plus 9” base = 35” minimum height requirement from the bottom of the line side lug(s) to the pad. See [E200.F.2](#).
- **For 1600A - 3000A Installations - Pad-mounted cabinets are required.**

ELECTRIC SERVICE EQUIPMENT

METER CABINETS

Issued Jan 2024

5. METERING TRANSFORMER CABINET SPECIFICATION - 600V Maximum

- Wall Mount (400A to 1200A) or Pad Mount (400A to 3000A)
- Bottom Entry / Top Exit
- Top Entry / Bottom Exit
- Bottom Entry / Bottom Exit
- 600 Volts Maximum

a) Table 3: WITH SIDE MOUNTED PT ENCLOSURE (NON-INTERNAL)

Ampacity	Lugs Per Phase	Lug Size	Conduit Size	Number of Conduits	Unprotected Fault Current Rating (Amps)	Minimum Width (Inches)	Minimum Depth (Inches)	Minimum "H" Dimension (Inches)	
								Wall	*Pad
400	2	4/0-500	4"	2	42,000	24	15	20	20
600	2	4/0-500	4"	2	42,000	24	15	20	20
800	3	4/0-500	4"	3	42,000	24	15	20	20
1200	5	4/0-500	4"	5	65,000	34	15	20	20
1600	4	500-1000	5"	4	65,000	38	15	n/a	35
2000	5	500-1000	5"	5	65,000	38	15	n/a	35
2500	7	500-1000	5"	7	65,000	42	21	n/a	35
3000	8	500-1000	5"	8	65,000	42	21	n/a	35

b) Table 4: WITH INTERNAL PT MOUNTING

Ampacity	Lugs Per Phase	Lug Size	Conduit Size	Number of Conduits	Unprotected Fault Current Rating (Amps)	Minimum Width (Inches)	Minimum Depth (Inches)	Minimum "H" Dimension (Inches)	
								Wall	*Pad
400	2	4/0-500	4"	2	42,000	32	15	20	20
600	2	4/0-500	4"	2	42,000	32	15	20	20
800	3	4/0-500	4"	3	42,000	32	15	20	20
1200	5	4/0-500	4"	5	65,000	42	15	20	20
1600	4	500-1000	5"	4	65,000	46	15	n/a	35
2000	5	500-1000	5"	5	65,000	46	15	n/a	35
2500	7	500-1000	5"	7	65,000	50	21	n/a	35
3000	8	500-1000	5"	8	65,000	50	21	n/a	35

Table Notes:

- Minimum criteria shown and may be exceeded to utilize manufacturer’s available equipment.
- See drawings in [E200.F. 1 & 2](#) for “H” dimension.
- * For pad mounted cabinets the 9” to 12” mounting base requirement is in addition to the required “H” dimension for cabinets 1600 amps or larger. 26” “H” plus 9” base = 35” minimum height requirement from the bottom of the line side lug(s) to the pad. See [E200.F.2](#).
- Minimum width does not include dimensions for a separate internal or external wire-way compartment for a Bottom Entry/Bottom Exit option or an External PT Enclosure dimensions.
- **For 1600A - 3000A Installations - Pad-mounted cabinets are required.**

6. TERMINATION CABINET SPECIFICATIONS

- Wall Mount (400A to 1200A) or Pad Mount (400A to 3000A)
- Bottom Entry / Top Exit
- Top Entry / Bottom Exit
- Bottom Entry / Bottom Exit

a) Table 5: 250 VOLTS MAXIMUM

Ampacity	Lugs per Phase	Lug Size	Conduit Size	Number of Conduits	Unprotected Fault Current Rating (Amps)	Minimum Width (Inches)	Minimum Depth (Inches)	Minimum "H" Dimension (Inches)	
								Wall	*Pad
400	2	4/0-500	4"	2	42,000	20	11	20	20
600	2	4/0-500	4"	2	42,000	24	14	20	20
800	3	4/0-500	4"	3	42,000	24	14	20	20
1200	5	4/0-500	4"	5	65,000	34	15	20	20
1600	4	500-1000	5"	4	65,000	38	15	n/a	35
2000	5	500-1000	5"	5	65,000	38	15	n/a	35
2500	7	500-1000	5"	7	65,000	42	21	n/a	35
3000	8	500-1000	5"	8	65,000	42	21	n/a	35

b) Table 6: 600 VOLTS MAXIMUM

Ampacity	Lugs per Phase	Lug Size	Conduit Size	Number of Conduits	Unprotected Fault Current Rating (Amps)	Minimum Width (Inches)	Minimum Depth (Inches)	Minimum "H" Dimension (Inches)	
								Wall	*Pad
400	2	4/0-500	4"	2	42,000	20	15	20	20
600	2	4/0-500	4"	2	42,000	24	15	20	20
800	3	4/0-500	4"	3	42,000	24	15	20	20
1200	5	4/0-500	4"	5	65,000	34	15	20	20
1600	4	500-1000	5"	4	65,000	38	15	n/a	35
2000	5	500-1000	5"	5	65,000	38	15	n/a	35
2500	7	500-1000	5"	7	65,000	42	21	n/a	35
3000	8	500-1000	5"	8	65,000	42	21	n/a	35

Table Notes:

- Minimum criteria shown and may be exceeded to utilize manufacturer's available equipment.
- See [drawings in E200.F. 1 & 2](#) for "H" dimension.
- * For pad mounted cabinets the 9" to 12" mounting base requirement is in addition to the required "H" dimension for cabinets 1600 amps or larger. 26" "H" plus 9" base = 35" minimum height requirement from the bottom of the line side lug(s) to the pad. See [E200.F.2.](#)
- Minimum width does not include dimensions for a separate internal or external wire-way compartment for a Bottom Entry / Bottom Exit option.
- For 1600A - 3000A Installations - Pad-mounted cabinets are required.

CHAPTER 2 - EQUIPMENT LIST HEADERS:**1. Amp Ratings -****Available Amp Ratings:**

400 Amp, 600 Amp, 800 Amp, 1200 Amp, 1600 Amp, 2000 Amp, 2500 Amp, 3000 Amp

2. Volts - Available maximum voltage rating.

250V = For use with 120/240V 1PH or for use with 120/208V 3PH

600V = For use with 277/480V 3PH

3. Ph. - The number of phases.

1PH = single-phase

3PH = three-phase

4. Mount -

WALL = Bolted or Lagged to a wall

PAD = Mounted on a concrete pad with conduit entry and exit

5. Manufacturer - Manufacturer of device.**6. Catalog Number -** Manufacturer identification number for the device.**7. Main Size (if applicable) -** Main Breaker Size (Amps).

2-200 = Two 200 amp breakers

400 = One 400 amp breaker

600 = One 600 amp breaker

800 = One 800 amp breaker

1200 = One 1200 amp breaker

MULTI = Multiple breaker size options are available, not to exceed amp rating of cabinet

8. SCCR - Short Circuit Current Rating (AMPS) for cabinet.

- Minimum cabinet requirements are shown in ESE E200.F. Tables 1-6.

- Breaker/equipment rating requirements are shown in ESR e-manual 110.

9. Notes - References applicable Note(s) on page 2-10 or listed beneath each section.**10. Wall Mounted Configurations -**

Top in/Bottom Out = Overhead service top entry/customer cables exit bottom

Bottom in/Top Out = Underground service bottom entry/customer cables exit top

Bottom in/Bottom Out = Underground service bottom entry/customer cables exit bottom

11. Pad-Mounted - Cabinet is allowed to be pad-mounted, bottom in, bottom out.

Bottom in/Bottom Out = Underground service bottom entry/customer cables exit bottom

For 1600A - 3000A Installations - Pad-mounted cabinets are required.



CHAPTER 2 - NOTES:

- (1) These CT cabinets are only allowed for 250 Volt applications, Residential Only.
- (2) Standard wireway, hinge and PT mount are on left side. Add "REVWW" to PO to change it to the right side.
- (3) Standard wireway, hinge and PT mount are on the Left side "L", change to "R" to move to the Right side
- (4) ** = Multiple breaker options available, part number will change depending on breaker
- (5) For Top In/Bottom Out, change the "A" in the CT designator to a "B"
- (6) Fill in * with L for Side Wiring Gutter on Left side or R for Right side
- (7) Fill in * with A for Top In / Bottom Out or B for Bottom In / Top Out
- (8) Requires either 38" wide enclosure with internal PT pan "-PT" or additional PT Enclosure - #PTB
- (9) Standard wireway, hinge and PT mount are on the Right side "R", change to "L" to move to the Left side
- (10) These devices may be pad-mounted but must also be anchored to building or wall to support the enclosure

ELECTRIC SERVICE EQUIPMENT

CABINETS

Issued Jan 2024

Manufacturer	Catalog Number	SCCR	Notes	Top In / Bottom Out	Bottom In / Top Out	Bottom In / Bottom Out
E201A. Metering Transformer Cabinets - 400 Amps (Residential Only)						
120/240V 1PH 400 Amp WALL						
A.M.P.						
	ALIRCT4-3L	85kA	(1)	X	X	
Galva Closure						
	ALI-RES-413	65kA	(1)	X	X	
120/208V 3PH 400 Amp WALL						
A.M.P.						
	ALIRCT4-4L	85kA	(1)	X	X	
Galva Closure						
	ALI-RES-434	65kA	(1)	X	X	
E201. Metering Transformer Cabinets - 400 Amps						
120/240V 1PH 400 Amp PAD						
A.M.P.						
	ALIECT4-3L CR15ECTS	85kA				X
	ALIPCT4-3R	85kA	(9)			X
Erickson Electric						
	CT41-ALI PMB1624x10	42kA				X
Milbank						
	ALIM-413PM	65kA	(2)			X
120/208V 3PH 400 Amp PAD						
A.M.P.						
	ALIECT4-4L CR15ECTS	85kA				X
	ALIPCT4-4R	85kA	(9)			X
Erickson Electric						
	CT44-ALI PMB1624x10	42kA				X
Milbank						
	ALIM-434PM	65kA	(2)			X
277/480V 3PH 400 Amp PAD						
A.M.P.						
	ALIECT4-4L CR15ECTS PTB36	85kA				X
	ALIPCT4-4PTR	85kA	(9)			X
Erickson Electric						
	CT44-PT-ALI PMB1624x10	42kA				X
Milbank						
	ALIM-464PM	65kA	(2)			X

NOTES:

- (1) These CT cabinets are only allowed for 250 Volt applications, Residential Only.
- (2) Standard wireway, hinge and PT mount are on left side. Add "REVWW" to PO to change it to the right side.
- (9) Standard wireway, hinge and PT mount are on the Right side "R", change to "L" to move to the Left side

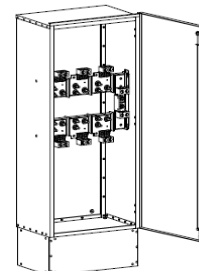

Pictured: CT44-ALI with PMB1624x10



ELECTRIC SERVICE EQUIPMENT

CABINETS

Issued Jan 2024

Manufacturer	Catalog Number	SCCR	Notes	Top In / Bottom Out	Bottom In / Top Out	Bottom In / Bottom Out
E201. Metering Transformer Cabinets - 400 Amps (continued)						
120/240V 1PH 400 Amp WALL						
A.M.P.						
	ALICT4-3	85kA		X	X	
	ALIECT4-3L	85kA		X	X	X
	ALICT4-3BR	85kA	(9)	X	X	X
EMI						
	ALICT140	65kA		X	X	
	ALICT140P	65kA				X
Erickson Electric						
	CT41-ALI	42kA		X	X	X
Milbank						
	ALIM-413	65kA		X	X	
	ALIM-413UGBX	65kA	(2)			X
120/208V 3PH 400 Amp WALL						
A.M.P.						
	ALICT4-4	85kA		X	X	
	ALIECT4-4L	85kA		X	X	X
	ALICT4-4BR	85kA	(9)	X	X	X
EMI						
	ALICT340	65kA		X	X	
Erickson Electric						
	CT44-ALI	42kA		X	X	X
Milbank						
	ALIM-434	65kA		X	X	
	ALIM-434UGBX	65kA	(2)			X
277/480V 3PH 400 Amp WALL						
A.M.P.						
	ALIECT4-4L PTB36	85kA		X	X	X
	ALICT4-4PTR	85kA	(9)		X	X
EMI						
	ALICT340P	65kA				X
Erickson Electric						
	CT44-PT-ALI	42kA		X	X	X
Milbank						
	ALIM-464	65kA		X	X	
	ALIM-464UGBX	65kA	(2)			X

NOTES:

- (2) Standard wireway, hinge and PT mount are on left side. Add "REVWW" to PO to change it to the right side.
- (9) Standard wireway, hinge and PT mount are on the Right side "R", change to "L" to move to the Left side

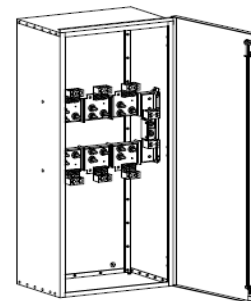

Pictured: CT44-ALI

ELECTRIC SERVICE EQUIPMENT

CABINETS

Issued Jan 2024

Manufacturer	Catalog Number	SCCR	Notes	Top In / Bottom Out	Bottom In / Top Out	Bottom In / Bottom Out
E202A. Metering Transformer Cabinets - 600 Amps (Residential Only)						
120/240V 1PH 600 Amp WALL						
A.M.P.						
	ALIRCT6-3L	85kA	(1)	X	X	
Galva Closure						
	ALI-RES-613	65kA	(1)	X	X	
120/208V 3PH 600 Amp WALL						
A.M.P.						
	ALIRCT6-4L	85kA	(1)	X	X	
Galva Closure						
	ALI-RES-634	65kA	(1)	X	X	
E202. Metering Transformer Cabinets - 600 Amps						
120/240V 1PH 600 Amp PAD						
A.M.P.						
	ALIECT6-3L CR15ECTS	85kA				X
	ALIPCT6-3R	85kA	(9)			X
Erickson Electric						
	CT61-ALI PMB1624x10	65kA				X
Milbank						
	ALIM-613PM	65kA	(2)			X
120/208V 3PH 600 Amp PAD						
A.M.P.						
	ALIECT6-4L CR15ECTS	85kA				X
	ALIPCT6-4R	85kA	(9)			X
Erickson Electric						
	CT64-ALI PMB1624x10	65kA				X
Milbank						
	ALIM-634PM	65kA	(2)			X
277/480V 3PH 600 Amp PAD						
A.M.P.						
	ALIECT6-4L CR15ECTS PTB36	85kA				X
	ALIPCT6-4PTR	85kA	(9)			X
Erickson Electric						
	CT64-PT-ALI PMB1624x10	65kA				X
Milbank						
	ALIM-664PM	65kA	(2)			X

NOTES:

- (1) These CT cabinets are only allowed for 250 Volt applications, Residential Only.
- (2) Standard wireway, hinge and PT mount are on left side. Add "REVWW" to PO to change it to the right side.
- (9) Standard wireway, hinge and PT mount are on the Right side "R", change to "L" to move to the Left side

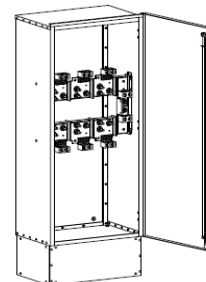

Pictured: CT64-ALI with PMB1624x10

ELECTRIC SERVICE EQUIPMENT

CABINETS

Issued Jan 2024

Manufacturer	Catalog Number	SCCR	Notes	Top In / Bottom Out	Bottom In / Top Out	Bottom In / Bottom Out
E202. Metering Transformer Cabinets - 600 Amps (continued)						
120/240V 1PH 600 Amp WALL						
A.M.P.						
	ALICT6-3	85kA		X	X	
	ALIECT6-3L	85kA		X	X	X
	ALICT6-3BR	85kA	(9)	X	X	X
EMI						
	ALICT160	65kA		X	X	
	ALICT160P	65kA				X
Erickson Electric						
	CT61-ALI	65kA		X	X	X
	CT61-ALI-SEA	65kA		X	X	
Milbank						
	ALIM-613	65kA		X	X	
	ALIM-613UGBX	65kA	(2)			X
120/208V 3PH 600 Amp WALL						
A.M.P.						
	ALICT6-4	85kA		X	X	
	ALIECT6-4L	85kA		X	X	X
	ALICT6-4BR	85kA	(9)	X	X	X
EMI						
	ALICT360	65kA		X	X	
Erickson Electric						
	CT64-ALI	65kA		X	X	X
	CT64-ALI-SEA	65kA		X	X	
Milbank						
	ALIM-634	65kA		X	X	
	ALIM-634UGBX	65kA	(2)			X
277/480V 3PH 600 Amp WALL						
A.M.P.						
	ALIECT6-4L PTB36	85kA		X	X	X
	ALICT6-4PTR	85kA	(9)		X	X
EMI						
	ALICT360P	65kA				X
Erickson Electric						
	CT64-PT-ALI	65kA		X	X	X
Milbank						
	ALIM-664	65kA		X	X	
	ALIM-664UGBX	65kA	(2)			X

NOTES:

- (2) Standard wireway, hinge and PT mount are on left side. Add "REVWW" to PO to change it to the right side.
- (9) Standard wireway, hinge and PT mount are on the Right side "R", change to "L" to move to the Left side

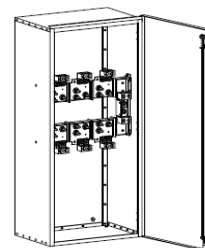

Pictured: CT64-ALI

ELECTRIC SERVICE EQUIPMENT

CABINETS

Issued Jan 2024

Manufacturer	Catalog Number	SCCR	Notes	Top In / Bottom Out	Bottom In / Top Out	Bottom In / Bottom Out
E203. Metering Transformer Cabinets - 800 Amps						
120/240V 1PH 800 Amp PAD						
A.M.P.						
	ALIECT8-3L CR15ECTS	85kA				X
	ALIPCT8-3R	85kA	(9)			X
Erickson Electric						
	CT81-ALI PMB1624x10	65kA				X
Milbank						
	ALIM-813PM	65kA	(2)			X
120/208V 3PH 800 Amp PAD						
A.M.P.						
	ALIECT8-4L CR15ECTS	85kA				X
	ALIPCT8-4R	85kA	(9)			X
Erickson Electric						
	CT84-ALI PMB1624x10	65kA				X
Milbank						
	ALIM-834PM	65kA	(2)			X
277/480V 3PH 800 Amp PAD						
A.M.P.						
	ALIECT8-4L CR15ECTS PTB36	85kA				X
	ALIPCT8-4PTR	85kA	(9)			X
Erickson Electric						
	CT84-PT-ALI PMB1624x10	65kA				X
Milbank						
	ALIM-864PM	65kA	(2)			X

NOTES:

- (2) Standard wireway, hinge and PT mount are on left side. Add "REVWW" to PO to change it to the right side.
- (9) Standard wireway, hinge and PT mount are on the Right side "R", change to "L" to move to the Left side

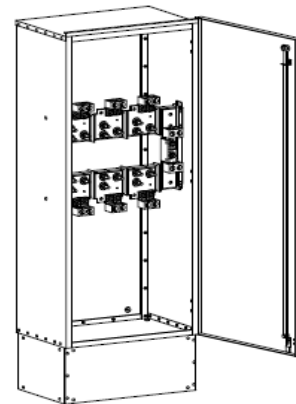

Pictured: CT84-ALI with PMB1624x10

ELECTRIC SERVICE EQUIPMENT

CABINETS

Issued Jan 2024

Manufacturer	Catalog Number	SCCR	Notes	Top In / Bottom Out	Bottom In / Top Out	Bottom In / Bottom Out
E203. Metering Transformer Cabinets - 800 Amps (continued)						
120/240V 1PH 800 Amp WALL						
A.M.P.						
	ALICT8-3	85kA		X	X	
	ALIECT8-3L	85kA		X	X	X
	ALICT8-3BR	85kA	(9)	X	X	X
EMI						
	ALICT180	65kA			X	
	ALICT180P	65kA				X
Erickson Electric						
	CT81-ALI	65kA		X	X	X
Milbank						
	ALIM-813	65kA		X	X	
	ALIM-813UGBX	65kA	(2)			X
120/208V 3PH 800 Amp WALL						
A.M.P.						
	ALICT8-4	85kA		X	X	
	ALIECT8-4L	85kA		X	X	X
	ALICT8-4BR	85kA	(9)	X	X	X
EMI						
	ALICT380	65kA			X	
Erickson Electric						
	CT84-ALI	65kA		X	X	X
Milbank						
	ALIM-834	65kA		X	X	
	ALIM-834UGBX	65kA	(2)			X
277/480V 3PH 800 Amp WALL						
A.M.P.						
	ALIECT8-4L PTB36	85kA		X	X	X
	ALICT8-4PTR	85kA	(9)		X	X
EMI						
	ALICT380P	65kA				X
Erickson Electric						
	CT84-PT-ALI	65kA		X	X	X
Milbank						
	ALIM-864	65kA		X	X	
	ALIM-864UGBX	65kA	(2)			X

NOTES:

- (2) Standard wireway, hinge and PT mount are on left side. Add "REVWW" to PO to change it to the right side.
- (9) Standard wireway, hinge and PT mount are on the Right side "R", change to "L" to move to the Left side

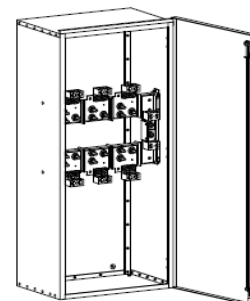

Pictured: CT84-ALI

ELECTRIC SERVICE EQUIPMENT

CABINETS

Issued Jan 2024

Manufacturer	Catalog Number	SCCR	Notes	Top In / Bottom Out	Bottom In / Top Out	Bottom In / Bottom Out
E204. Metering Transformer Cabinets - 1200 Amps						
120/208V 3PH 1200 Amp PAD						
A.M.P.						
	ALIPCT12-4R	85kA	(9)			X
Erickson Electric						
	PMCT124-MF-ALI	100kA				X
Milbank						
	ALIM-1234PM	85kA	(2)			X
277/480V 3PH 1200 Amp PAD						
A.M.P.						
	ALIPCT12-4PTR	85kA	(9)			X
Erickson Electric						
	PMCT124-MF-PT-ALI	100kA				X
Milbank						
	ALIM-1264PM	85kA	(2)			X
120/208V 3PH 1200 Amp WALL						
A.M.P.						
	ALICT12-4	85kA		X	X	
	ALIECT12-4L	85kA		X	X	X
	ALICT12-4BR	85kA	(9)	X	X	X
EMI						
	ALICT312	65kA			X	
Erickson Electric						
	CT124-ALI	100kA		X	X	
	CT124-SG*-ALI	100kA	(6)			X
Milbank						
	ALIM-1234	85kA		X	X	
	ALIM-1234UGBX	85kA	(2)			X
277/480V 3PH 1200 Amp WALL						
A.M.P.						
	ALIECT12-4L PTB36	85kA		X	X	X
	ALICT12-4PTR	85kA	(9)		X	X
EMI						
	ALICT312P	65kA				X
Erickson Electric						
	CT124-PT-ALI	100kA		X	X	
	CT124-PT-SG*-ALI	100kA	(6)			X
Milbank						
	ALIM-1264	85kA		X	X	
	ALIM-1264UGBX	85kA	(2)			X

NOTES:

- (2) Standard wireway, hinge and PT mount are on left side. Add "REVWW" to PO to change it to the right side.
- (6) Fill in * with L for Side Wiring Gutter on Left side or R for Right side
- (9) Standard wireway, hinge and PT mount are on the Right side "R", change to "L" to move to the Left side

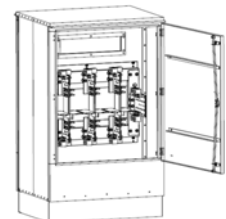

Pictured: PMCT124-MF-ALI

ELECTRIC SERVICE EQUIPMENT

CABINETS

Issued Jan 2024

Manufacturer	Catalog Number	SCCR	Notes	Top In / Bottom Out	Bottom In / Top Out	Bottom In / Bottom Out
E205. Metering Transformer Cabinets - 1600 Amps						
120/208V 3PH 1600 Amp PAD						
A.M.P.						
	ALIPCT16-4R	85kA	(9)			X
Erickson Electric						
	PMCT164-MF-ALI	100kA				X
Milbank						
	ALIM-1634PM	85kA	(2)			X
277/480V 3PH 1600 Amp PAD						
A.M.P.						
	ALIPCT16-4PTR	85kA	(9)			X
Erickson Electric						
	PMCT164-MF-PT-ALI	100kA				X
Milbank						
	ALIM-1664PM	85kA	(2)			X
E206. Metering Transformer Cabinets - 2000 Amps						
120/208V 3PH 2000 Amp PAD						
A.M.P.						
	ALIPCT20-4R	85kA	(9)			X
Erickson Electric						
	PMCT204-MF-ALI	100kA				X
	PMCTCC4210N-MF-ALI	85kA				X
Milbank						
	ALIM-2034PM	85kA	(2)			X
277/480V 3PH 2000 Amp PAD						
A.M.P.						
	ALIPCT20-4PTR	85kA	(9)			X
Erickson Electric						
	PMCT204-MF-PT-ALI	100kA				X
	PMCTCC4610N-MF-PT-ALI	85kA				X
Milbank						
	ALIM-2064PM	85kA	(2)			X

NOTES:

- (2) Standard wireway, hinge and PT mount are on left side. Add "REVWW" to PO to change it to the right side.
- (9) Standard wireway, hinge and PT mount are on the Right side "R", change to "L" to move to the Left side

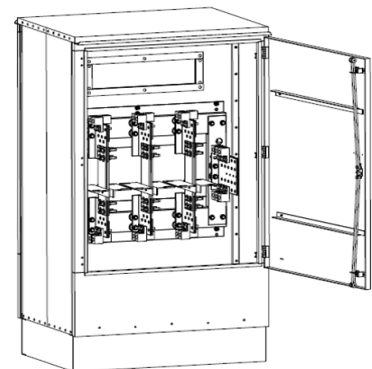

Pictured: PMCT164-MF-ALI

ELECTRIC SERVICE EQUIPMENT

CABINETS

Issued Jan 2024

Manufacturer	Catalog Number	SCCR	Notes	Top In / Bottom Out	Bottom In / Top Out	Bottom In / Bottom Out
E207. Metering Transformer Cabinets - 2500 Amps						
120/208V 3PH 2500 Amp PAD						
A.M.P.						
	ALIPCT25-4R	85kA	(9)			X
Erickson Electric						
	PMCT254-MF-ALI	100kA				X
	PMCTCC4211N-MF-ALI	85kA				X
Milbank						
	ALIM-2534PM	85kA	(2)			X
277/480V 3PH 2500 Amp PAD						
A.M.P.						
	ALIPCT25-4PTR	85kA	(9)			X
Erickson Electric						
	PMCT254-MF-PT-ALI	100kA				X
	PMCTCC4611N-MF-PT-ALI	85kA				X
Milbank						
	ALIM-2564PM	85kA	(2)			X
E208. Metering Transformer Cabinets - 3000 Amps						
120/208V 3PH 3000 Amp PAD						
A.M.P.						
	ALIPCT30-4R	85kA	(9)			X
Erickson Electric						
	PMCT304-MF-ALI	100kA				X
	PMCTCC4212N-MF-ALI	85kA				X
Milbank						
	ALIM-3034PM	85kA	(2)			X
277/480V 3PH 3000 Amp PAD						
A.M.P.						
	ALIPCT30-4PTR	85kA	(9)			X
Erickson Electric						
	PMCT304-MF-PT-ALI	100kA				X
	PMCTCC4612N-MF-PT-ALI	85kA				X
Milbank						
	ALIM-3064PM	85kA	(2)			X

NOTES:

- (2) Standard wireway, hinge and PT mount are on left side. Add "REVWW" to PO to change it to the right side.
- (9) Standard wireway, hinge and PT mount are on the Right side "R", change to "L" to move to the Left side

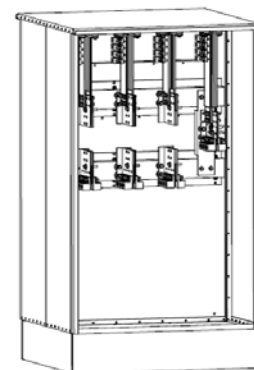

Pictured: PMCT254-MF-ALI

ELECTRIC SERVICE EQUIPMENT

CABINETS

Issued Jan 2024

Manufacturer	Catalog Number	Main Size	SCCR	Notes	Top In / Bottom Out	Bottom In / Top Out	Bottom In / Bottom Out
E209. Metering Transformer Cabinets w/Main - 400 Amps							
120/240V 1PH 400 Amp PAD							
Erickson Electric							
	PMCTMS-325N-MF-ALI	400	100kA				X
Milbank							
	ALIM-CT**22L-413PM	2-200	65kA	(3)(4)			X
	ALIM-CT**12L-413PM	400	65kA	(3)(4)			X
120/208V 3PH 400 Amp PAD							
Erickson Electric							
	PMCTMS-425N-MF-ALI	400	100kA				X
Milbank							
	ALIM-CT**22L-434PM	2-200	65kA	(3)(4)			X
	ALIM-CT**12L-434PM	400	65kA	(3)(4)			X
277/480V 3PH 400 Amp PAD							
Erickson Electric							
	PMCTMS-465N-MF-PT-ALI	400	100kA				X
Milbank							
	ALIM-CT**24L-464PM	2-200	65kA	(3)(4)			X
	ALIM-CT**14L-464PM	400	65kA	(3)(4)			X
120/240V 1PH 400 Amp WALL							
A.M.P.							
	ALIMCT225J	400	100kA	(10)	X	X	X
	ALISCT4-3L	MULTI	42kA	(10)	X	X	X
	ALISCT4-3DT	400	85kA			X	
	ALISCT4-3DTH	400	85kA			X	X
Erickson Electric							
	ALI-CT*-ED-3244N	2-200	65kA	(7)	X	X	
	ALI-CT*-P-3244N	2-200	200kA	(7)	X	X	
	ALI-CT*-DK-325N	400	65kA	(7)	X	X	
	ALI-CT*-P-325N	400	200kA	(7)	X	X	
Milbank							
	ALIM-CT**22A-413	2-200	65kA	(4)(5)	X	X	
	ALIM-CT**12A-413	400	65kA	(4)(5)	X	X	
	ALIM-CT**12L-413UGBX	400	65kA	(3)(4)			X
	ALIM-CT**22L-413UGBX	2-200	65kA	(3)(4)			X

NOTES:

- (3) Standard wireway, hinge and PT mount are on the Left side "L", change to "R" to move to the Right side
- (4) ** = Multiple breaker options available, part number will change depending on breaker
- (5) For Top In/Bottom Out, change the "A" in the CT designator to a "B"
- (7) Fill in * with A for Top In / Bottom Out or B for Bottom In / Top Out
- (10) These devices may be pad-mounted but must also - be anchored to building or wall to support the enclosure

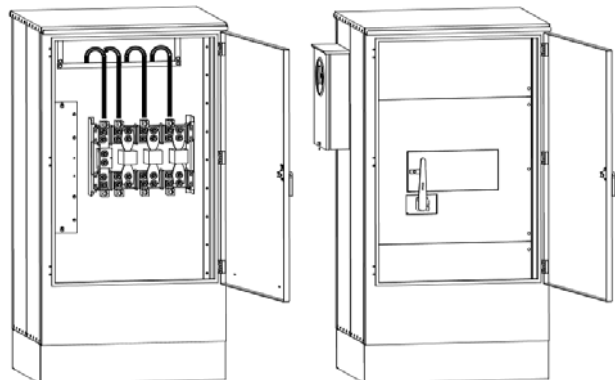

Pictured: PMCTMS-465N-MF-PT-ALI

ELECTRIC SERVICE EQUIPMENT

CABINETS

Issued Jan 2024

Manufacturer	Catalog Number	Main Size	SCCR	Notes	Top In / Bottom Out	Bottom In / Top Out	Bottom In / Bottom Out
E209. Metering Transformer Cabinets w/Main - 400 Amps (continued)							
120/208V 3PH 400 Amp WALL							
A.M.P.							
	ALIMCT325J	400	100kA	(10)	X	X	X
	ALIMCT365J	400	100kA	(10)	X	X	X
	ALISCT4-4L	MULTI	42kA	(10)	X	X	X
	ALISCT4-4DT	400	85kA			X	
	ALISCT4-4DTH	400	85kA			X	X
Erickson Electric							
	ALI-CT*-ED-4244N	2-200	65kA	(7)	X	X	
	ALI-CT*-P-4244N	2-200	200kA	(7)	X	X	
	ALI-CT*-DK-425N	400	65kA	(7)	X	X	
	ALI-CT*-P-425N	400	200kA	(7)	X	X	
Milbank							
	ALIM-CT**22A-434	2-200	65kA	(4)(5)	X	X	
	ALIM-CT**12A-434	400	65kA	(4)(5)	X	X	
	ALIM-CT**12L-434UGBX	400	65kA	(3)(4)			X
	ALIM-CT**22L-434UGBX	2-200	65kA	(3)(4)			X
277/480V 3PH 400 Amp WALL							
A.M.P.							
	ALIMCT365J & AMEPTB36-GRY	400	100kA	(8)(10)	X	X	X
	ALI6SCT4-4L & AMEPTB36-GRY	MULTI	42kA	(8)(10)	X	X	X
EMI							
	ALIMSCT4-PT or #PTB	400	65kA	(8)			X
Erickson Electric							
	ALI-CT*-P-4644N-PT	2-200	200kA	(7)	X	X	
	ALI-CT*-P-465N-PT	400	200kA	(7)	X	X	
Milbank							
	ALIM-CT**14A-464	400	65kA	(4)(5)	X	X	
	ALIM-CT**14L-464UGBX	400	65kA	(3)(4)			X
	ALIM-CT**24L-464UGBX	2-200	65kA	(3)(4)			X

NOTES:

- (3) Standard wireway, hinge and PT mount are on the Left side "L", change to "R" to move to the Right side
- (4) ** = Multiple breaker options available, part number will change depending on breaker
- (5) For Top In/Bottom Out, change the "A" in the CT designator to a "B"
- (7) Fill in * with A for Top In / Bottom Out or B for Bottom In / Top Out
- (8) Requires either 38" wide enclosure with internal PT pan - PT or additional PT Enclosure - #PTB
- (10) These devices may be pad-mounted but must also - be anchored to building or wall to support the enclosure

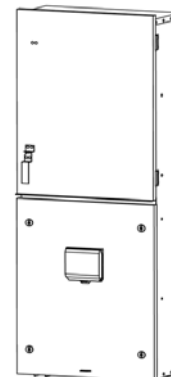

Pictured: ALI-CTA-DK-425N

ELECTRIC SERVICE EQUIPMENT

CABINETS

Issued Jan 2024

Manufacturer	Catalog Number	Main Size	SCCR	Notes	Top In / Bottom Out	Bottom In / Top Out	Bottom In / Bottom Out
E210. Metering Transformer Cabinets w/Main - 600 Amps							
120/240V 1PH 600 Amp PAD							
Erickson Electric							
	PMCTMS-326N-MF-ALI	600	100kA				X
Milbank							
	ALIM-CT**12L-613PM	600	65kA	(3)(4)			X
120/208V 3PH 600 Amp PAD							
Erickson Electric							
	PMCTMS-426N-MF-ALI	600	100kA				X
Milbank							
	ALIM-CT**12L-634PM	600	65kA	(3)(4)			X
277/480V 3PH 600 Amp PAD							
Erickson Electric							
	PMCTMS-466N-MF-PT-ALI	600	100kA				X
Milbank							
	ALIM-CT**14L-664PM	600	65kA	(3)(4)			X
120/240V 1PH 600 Amp WALL							
A.M.P.							
	ALIMCT226J	600	100kA	(10)	X	X	X
	ALISCT6-3L	MULTI	65kA	(10)	X	X	X
Milbank							
	ALIM-CT**12A-613	600	65kA	(4)(5)	X	X	
	ALIM-CT**12L-613UGBX	600	65kA	(3)(4)			X
120/208V 3PH 600 Amp WALL							
A.M.P.							
	ALIMCT326J	600	100kA	(10)	X	X	X
	ALISCT6-4L	MULTI	65kA	(10)	X	X	X
	ALIMCT366J	600	100kA	(10)	X	X	X
Milbank							
	ALIM-CT**12A-634	600	65kA	(4)(5)	X	X	
	ALIM-CT**12L-634UGBX	600	65kA	(3)(4)			X
277/480V 3PH 600 Amp WALL							
A.M.P.							
	ALIMCT366J & AMEPTB36-GRY	600	100kA	(8)(10)	X	X	X
	ALI6SCT6-4L & AMEPTB36-GRY	MULTI	65kA	(8)(10)	X	X	X
EMI							
	ALIMSCT6-PT or #PTB	600	65kA	(8)			X
Milbank							
	ALIM-CT**14A-664	600	65kA	(4)(5)	X	X	
	ALIM-CT**14L-664UGBX	600	65kA	(3)(4)			X

NOTES:

- (3) Standard wireway, hinge and PT mount are on the Left side "L", change to "R" to move to the Right side
- (4) ** = Multiple breaker options available, part number will change depending on breaker
- (5) For Top In/Bottom Out, change the "A" in the CT designator to a "B"
- (8) Requires either 38" wide enclosure with internal PT pan - PT or additional PT Enclosure - #PTB
- (10) These devices may be pad-mounted but must also - be anchored to building or wall to support the enclosure



Pictured: ALI-CTMGL12L-634UGBX

ELECTRIC SERVICE EQUIPMENT

CABINETS

Issued Jan 2024

Manufacturer	Catalog Number	Main Size	SCCR	Notes	Top In / Bottom Out	Bottom In / Top Out	Bottom In / Bottom Out
E211. Metering Transformer Cabinets w/Main - 800 Amps							
120/240V 1PH 800 Amp PAD							
Erickson Electric							
	PMCTMS-327N-MF-ALI	800	100kA				X
Milbank							
	ALIM-CT**12L-813PM	800	65kA	(3)(4)			X
120/208V 3PH 800 Amp PAD							
Erickson Electric							
	PMCTMS-427N-MF-ALI	800	100kA				X
Milbank							
	ALIM-CT**12L-834PM	800	65kA	(3)(4)			X
277/480V 3PH 800 Amp PAD							
Erickson Electric							
	PMCTMS-467N-MF-PT-ALI	800	100kA				X
Milbank							
	ALIM-CT**14L-864PM	800	65kA	(3)(4)			X
120/240V 1PH 800 Amp WALL							
A.M.P.							
	ALIMCT227L	800	100kA	(10)	X	X	X
	ALISCT8-3L	MULTI	65kA	(10)	X	X	X
Milbank							
	ALIM-CT**12A-813	800	65kA	(4)(5)	X	X	
	ALIM-CT**12L-813UGBX	800	65kA	(3)(4)			X
120/208V 3PH 800 Amp WALL							
A.M.P.							
	ALIMCT327L	800	100kA	(10)	X	X	X
	ALISCT8-4L	MULTI	65kA	(10)	X	X	X
	ALIMCT367L	800	100kA	(10)	X	X	X
Milbank							
	ALIM-CT**12A-834	800	65kA	(4)(5)	X	X	
	ALIM-CT**12L-834UGBX	800	65kA	(3)(4)			X
277/480V 3PH 800 Amp WALL							
A.M.P.							
	ALIMCT367L AMEPTB36-GRY	800	100kA	(10)	X	X	X
	ALI6SCT8-4L AMEPTB36-GRY	MULTI	65kA	(10)	X	X	X
EMI							
	ALIMSCT8-PT or #PTB	800	65kA	(8)			X
Milbank							
	ALIM-CT**14A-864	800	65kA	(4)(5)	X	X	
	ALIM-CT**14L-864UGBX	800	65kA	(3)(4)			X

NOTES:

- (3) Standard wireway, hinge and PT mount are on the Left side "L", change to "R" to move to the Right side
- (4) ** = Multiple breaker options available, part number will change depending on breaker
- (5) For Top In/Bottom Out, change the "A" in the CT designator to a "B"
- (8) Requires either 38" wide enclosure with internal PT pan - PT or additional PT Enclosure - #PTB
- (10) These devices may be pad-mounted but must also - be anchored to building or wall to support the enclosure

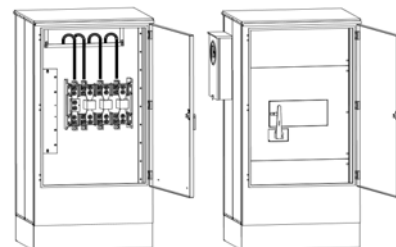

Pictured: PMCTMS-467N-MF-PT-ALI

ELECTRIC SERVICE EQUIPMENT

CABINETS

Issued Jan 2024

Manufacturer	Catalog Number	Main Size	SCCR	Notes	Top In / Bottom Out	Bottom In / Top Out	Bottom In / Bottom Out
E212. Metering Transformer Cabinets w/Main - 1200 Amps							
120/208V 3PH 1200 Amp PAD							
Erickson Electric							
	PMCTMS-428N-MF-ALI	1200	100kA				X
Milbank							
	ALIM-CT**12L-1234PM	1200	65kA	(3)(4)			X
277/480V 3PH 1200 Amp PAD							
Erickson Electric							
	PMCTMS-468NG6-MF-PT-ALI	1200	100kA				X
Milbank							
	ALIM-CT**14L-1264PM	1200	65kA	(3)(4)			X
120/208V 3PH 1200 Amp WALL							
A.M.P.							
	ALIMCT368L	1200	100kA	(10)	X	X	X
Milbank							
	ALIM-CT**12A-1234	1200	65kA	(4)(5)	X	X	
	ALIM-CT**12L-1234UGBX	1200	65kA	(3)(4)			X
277/480V 3PH 1200 Amp WALL							
A.M.P.							
	ALISCT12-4L	MULTI	65kA	(10)	X	X	X
	ALIMCT368L AMEPTB36-GRY	1200	100kA	(10)	X	X	X
Milbank							
	ALIM-CT**14A-1264	1200	65kA	(4)(5)	X	X	
	ALIM-CT**14L-1264UGBX	1200	65kA	(3)(4)			X

NOTES:

- (3) Standard wireway, hinge and PT mount are on the Left side "L", change to "R" to move to the Right side
- (4) ** = Multiple breaker options available, part number will change depending on breaker
- (5) For Top In/Bottom Out, change the "A" in the CT designator to a "B"
- (10) These devices may be pad-mounted but must also - be anchored to building or wall to support the enclosure

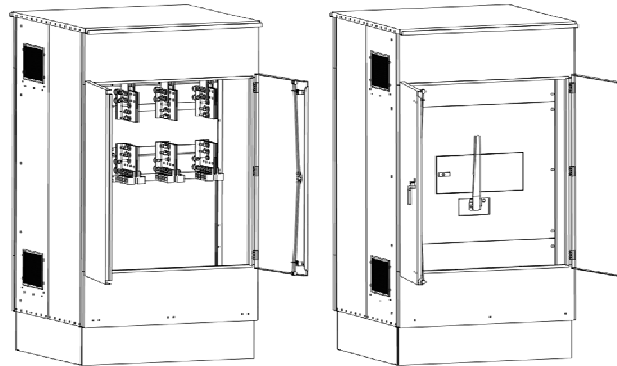

Pictured: PMCTMS-428N-MF-ALI

ELECTRIC SERVICE EQUIPMENT

CABINETS

Issued Jan 2024

Manufacturer	Catalog Number	Main Size	SCCR	Notes	Top In / Bottom Out	Bottom In / Top Out	Bottom In / Bottom Out
E213. Metering Transformer Cabinets w/Main - 1600 Amps							
120/208V 3PH 1600 Amp PAD							
Erickson Electric							
	PMCTMS-429N-MF-ALI	1600	100kA				X
277/480V 3PH 1600 Amp PAD							
Erickson Electric							
	PMCTMS-469G6-MF-PT-ALI	1600	100kA				X
E214. Metering Transformer Cabinets w/Main - 2000 Amps							
120/208V 3PH 2000 Amp PAD							
Erickson Electric							
	PMCTMS-4210N-MF-ALI	2000	100kA				X
277/480V 3PH 2000 Amp PAD							
Erickson Electric							
	PMCTMS-4610NG6-MF-PT-ALI	2000	100kA				X
E215. Metering Transformer Cabinets w/Main - 2500 Amps							
120/208V 3PH 2500 Amp PAD							
Erickson Electric							
	PMCTMS-4211N-MF-ALI	2500	100kA				X
277/480V 3PH 2500 Amp PAD							
Erickson Electric							
	PMCTMS-4611NG6-MF-PT-ALI	2500	100kA				X
E216. Metering Transformer Cabinets w/Main - 3000 Amps							
120/208V 3PH 3000 Amp PAD							
Erickson Electric							
	PMCTMS-4212N-MF-ALI	3000	100kA				X
277/480V 3PH 3000 Amp PAD							
Erickson Electric							
	PMCTMS-4612NG6-MF-PT-ALI	3000	100kA				X

Pictured: PMCTMS-429N-MF-ALI

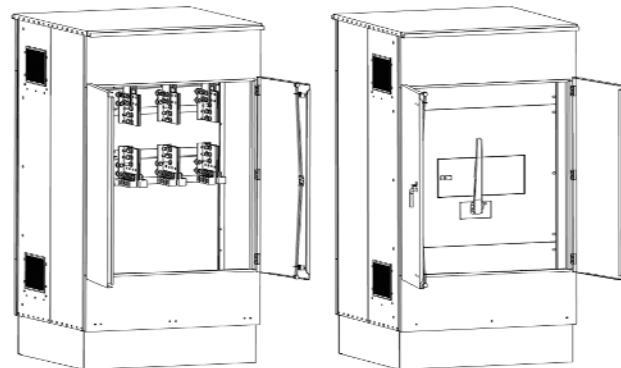



ELECTRIC SERVICE EQUIPMENT

CABINETS

Issued Jan 2024

Manufacturer	Catalog Number	SCCR	Notes	Top In / Bottom Out	Bottom In / Top Out	Bottom In / Bottom Out
E217. Termination Boxes - 400 Amps Max						
120/240V 1PH 400 Amp PAD						
A.M.P.						
	ALIPTC4-3R	85kA	(9)			X
Milbank						
	TBPMALIM-413-1	65kA				X
120/208V or 277/480V 3PH 400 Amp PAD						
A.M.P.						
	ALIPTC4-4R	85kA	(9)			X
Milbank						
	TBPMALIM-434-1	65kA				X
120/240V 1PH 400 Amp WALL						
A.M.P.						
	ALITC4-3	85kA		X	X	
	ALITC4-3BR	85kA	(9)	X	X	X
EMI						
	ALITB140	65kA		X	X	
Erickson Electric						
	ALI-TB-365N	42kA		X	X	X
Milbank						
	TBALIM-413-1	65kA		X	X	
	TBBXALIM-413-1	65kA				X
120/208V or 277/480V 3PH 400 Amp WALL						
A.M.P.						
	ALITC4-4	85kA		X	X	
	ALITC4-4BR	85kA	(9)	X	X	X
EMI						
	ALITB340	65kA		X	X	
Erickson Electric						
	ALI-TB-465N	42kA		X	X	X
Milbank						
	TBALIM-434-1	65kA		X	X	
	TBBXALIM-434-1	65kA				X

NOTES:

(9) Standard wireway, hinge and PT mount are on the Right side "R", change to "L" to move to the Left side

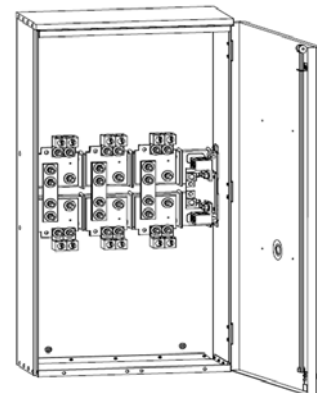

Pictured: ALI-TB-465N

ELECTRIC SERVICE EQUIPMENT

CABINETS

Issued Jan 2024

Manufacturer	Catalog Number	SCCR	Notes	Top In / Bottom Out	Bottom In / Top Out	Bottom In / Bottom Out
E218. Termination Boxes - 600 Amps Max						
120/240V 1PH 600 Amp PAD						
A.M.P.						
	AL IPTC6-3R	85kA	(9)			X
Milbank						
	TBPMALIM-613-2	65kA				X
120/208V or 277/480V 3PH 600 Amp PAD						
A.M.P.						
	AL IPTC6-4R	85kA	(9)			X
Milbank						
	TBPMALIM-634-2	65kA				X
120/240V 1PH 600 Amp WALL						
A.M.P.						
	ALITC6-3	85kA		X	X	
	ALITC6-3BR	85kA	(9)	X	X	X
EMI						
	ALITB160	65kA		X	X	
Erickson Electric						
	ALI-TB-366N	65kA		X	X	X
Milbank						
	TBALIM-613-2	65kA		X	X	
	TBBXALIM-613-2	65kA				X
120/208V or 277/480V 3PH 600 Amp WALL						
A.M.P.						
	ALITC6-4	85kA		X	X	
	ALITC6-4BR	85kA	(9)	X	X	X
EMI						
	ALITB360	65kA		X	X	
Erickson Electric						
	ALI-TB-466N	65kA		X	X	X
Milbank						
	TBALIM-634-2	65kA		X	X	
	TBBXALIM-634-2	65kA				X

NOTES:

(9) Standard wireway, hinge and PT mount are on the Right side "R", change to "L" to move to the Left side

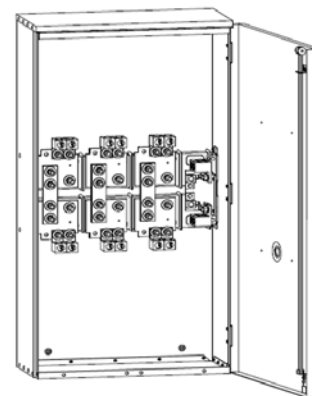

Pictured: ALI-TB-466N

ELECTRIC SERVICE EQUIPMENT

CABINETS

Issued Jan 2024

Manufacturer	Catalog Number	SCCR	Notes	Top In / Bottom Out	Bottom In / Top Out	Bottom In / Bottom Out
E219. Termination Boxes - 800 Amps Max						
120/240V 1PH 800 Amp PAD						
A.M.P.						
	ALIPTC8-3R	85kA	(9)			X
Milbank						
	TBPMALIM-813-1	65kA				X
120/208V or 277/480V 3PH 800 Amp PAD						
A.M.P.						
	ALIPTC8-4R	85kA	(9)			X
Milbank						
	TBPMALIM-834-1	65kA				X
120/240V 1PH 800 Amp WALL						
A.M.P.						
	ALITC8-3	85kA		X	X	
	ALITC8-3BR	85kA	(9)	X	X	X
EMI						
	ALITB180	65kA		X	X	
Erickson Electric						
	ALI-TB-367N	65kA		X	X	X
Milbank						
	TBALIM-813-3	65kA		X	X	
	TBBXALIM-813-3	65kA				X
120/208V or 277/480V 3PH 800 Amp WALL						
A.M.P.						
	ALITC8-4	85kA		X	X	
	ALITC8-4BR	85kA	(9)	X	X	X
EMI						
	ALITB380	65kA		X	X	
Erickson Electric						
	ALI-TB-467N	65kA		X	X	X
Milbank						
	TBALIM-834-3	65kA		X	X	
	TBBXALIM-834-3	65kA				X

NOTES:

(9) Standard wireway, hinge and PT mount are on the Right side "R", change to "L" to move to the Left side

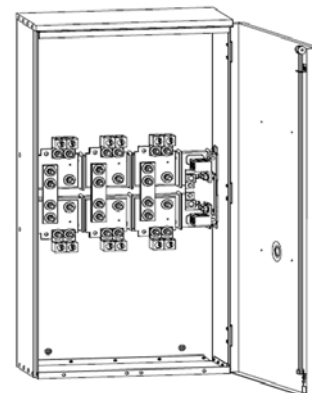

Pictured: ALI-TB-467N

ELECTRIC SERVICE EQUIPMENT

CABINETS

Issued Jan 2024

Manufacturer	Catalog Number	SCCR	Notes	Top In / Bottom Out	Bottom In / Top Out	Bottom In / Bottom Out
E220. Termination Boxes - 1200 Amps Max						
120/208V or 277/480V 3PH 1200 Amp PAD						
A.M.P.						
	ALIPTC12-4R	85kA				X
Erickson Electric						
	ALI-PMTB-468N	100kA				X
Milbank						
	TBPMALIM-1234-5	85kA				X
120/208V or 277/480V 3PH 1200 Amp WALL						
A.M.P.						
	ALITC12-4	85kA		X	X	
	ALITC12-4BR	85kA	(9)	X	X	X
EMI						
	ALITB312	65kA		X	X	
Erickson Electric						
	ALI-TB-468N	100kA		X	X	
	ALI-TB-468NSG*	100kA	(6)			X
Milbank						
	TBALIM-1234-5	85kA		X	X	
	TBBXALIM-1234-5	85kA				X
E221. Termination Boxes - 1600 Amps Max						
120/208V or 277/480V 3PH 1600 Amp PAD						
A.M.P.						
	ALIPTC16-4R	85kA	(9)			X
EMI						
	ALITB316	65kA				X
Erickson Electric						
	ALI-PMTB-469N	100kA				X
Milbank						
	TBPMALIM-1634-4	85kA				X

NOTES:

- (6) Fill in * with L for Side Wiring Gutter on Left side or R for Right side
- (9) Standard wireway, hinge and PT mount are on the Right side "R", change to "L" to move to the Left side

Pictured: ALI-TB-468N

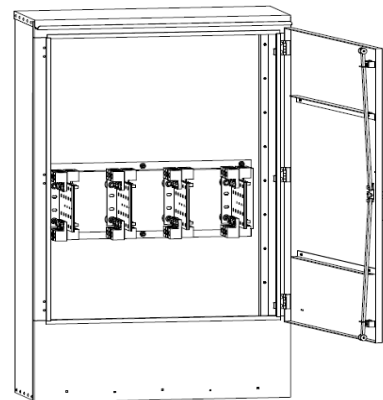

ELECTRIC SERVICE EQUIPMENT

CABINETS

Issued Jan 2024

Manufacturer	Catalog Number	SCCR	Notes	Top In / Bottom Out	Bottom In / Top Out	Bottom In / Bottom Out
E222. Termination Boxes - 2000 Amps Max						
120/208V or 277/480V 3PH 2000 Amp PAD						
A.M.P.						
	ALIPTC20-4R	85kA	(9)			X
EMI						
	ALITB320	65kA				X
Erickson Electric						
	ALI-PMTB-4610N	100kA				X
	PMCTCC4610N-TB-ALI	85kA				X
Milbank						
	TBPMALIM-2034-5	85kA				X
E223. Termination Boxes - 2500 Amps Max						
120/208V or 277/480V 3PH 2500 Amp PAD						
A.M.P.						
	ALIPTC25-4R	85kA	(9)			X
EMI						
	ALITB325	65kA				X
Erickson Electric						
	ALI-PMTB-4611N	100kA				X
	PMCTCC4611N-TB-ALI	85kA				X
Milbank						
	TBPMALIM-2534-7	85kA				X
E224. Termination Boxes - 3000 Amps Max						
120/208V or 277/480V 3PH 3000 Amp PAD						
A.M.P.						
	ALIPTC30-4R	85kA	(9)			X
EMI						
	ALITB330	65kA				X
Erickson Electric						
	ALI-PMTB-4612N	100kA				X
	PMCTCC4612N-TB-ALI	85kA				X
Milbank						
	TBPMALIM-3034-8	85kA				X

NOTES:

(9) Standard wireway, hinge and PT mount are on the Right side "R", change to "L" to move to the Left side

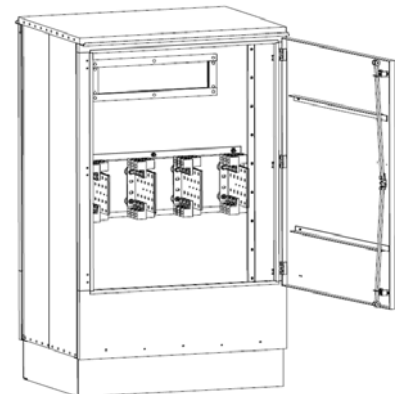

Pictured: ALI-PMTB-4610N



ELECTRIC SERVICE EQUIPMENT

ADDITIONAL EQUIPMENT INFORMATION

Issued Jan 2024

CHAPTER 3

ELECTRIC SERVICE EQUIPMENT – ADDITIONAL EQUIPMENT INFORMATION

E300. SCOPE

This chapter includes additional equipment that may be approved for use in Alliant Energy service territory but does not fit into the typical Meter Socket or typical Metering Cabinet classification. All requirements of ESE e-manual Chapters 1 & 2 that still apply shall be met.

E301 - E308. HORIZONTAL BUSSED EQUIPMENT

HORIZONTAL BUSSED MULTI-METERING NOTES:

- (1) # = Multiple catalog numbers, approved for positions as shown next to catalog number (Siemens/Talon)
- (2) 3 phase input/1 phase 120/208 at each meter position
- (3) # = Select number: 2, 3, or 4 for number of positions (Erickson)
- (4) # = Select number: 2, 3, 4, or 5 for number of positions (GE)
- (5) # = Select number: 2, 3, or 4 for number of positions (GE)
- (6) # = Select number: 1, 2, 3, or 4 for number of positions (GE)
- (7) Requires two tenant breakers with maximum sum of 300A. Cannot be used to serve a single 300A main. (GE)
- (8) Requires 300 amp tenant breaker to be installed. (GE)
- (9) # = Select number: 3, 4, or 5 for number of positions (Square D)
- (10) # = Select number: 2, 3, 4, or 5 for number of positions (Square D)
- (11) # = Select number: 1, 2, 3, or 4 for number of positions (Square D)
- (12) # = Select number: 1 or 2 for number of positions (Square D)
- (13) EZML requires deep well end covers. Shallow end covers shall never be used. (Square D)
- (14) # = Multiple catalog numbers, approved for positions as shown next to catalog number (Eaton-CH)

HORIZONTAL BUSSED CABINET NOTES:

- (15) Fill in * with A for Top In / Bottom Out or B for Bottom In / Top Out (Erickson)
- (16) CM-8 suffix indicates 1200A horizontal bus. CM-8 can be replaced with CM-9 for a 1600A horizontal bus or CM-7 for an 800A horizontal bus. (Erickson)
- (17) -() = Available from multiple manufacturers: [Erickson (blank), Eaton-Cutler Hammer (-CH)]

ELECTRIC SERVICE EQUIPMENT

METER SOCKETS

Issued Jan 2024

Manufacturer	Use	Catalog Number	Bypass	Mount	SCCR	Notes
E301. Multi-position Residential: Modular (bussed sections)						
120/240V 1PH-in, 1PH-out 4-Terminal 100 Amp						
Eaton-CH						
	OH/UG	1MM#12RRLB (2-5 Position)	Horn	PANEL	10kA	(1)
Siemens/Talon						
	OH/UG	WMM#1125RB (2-5 position)	Horn	PANEL	65kA	(1)
Square D						
	OH/UG	EZMH11#125 (3-5 position)	Horn	PANEL	10kA	(1)
120/240V 1PH-in, 1PH-out 4-Terminal 200 Amp						
Eaton-CH						
	OH/UG	1MM#20RRLB (2-4 Position)	Horn	PANEL	10kA	(1)
Erickson Electric						
	OH/UG	1RM**4-# (2-4 position)	Horn	PANEL	10kA	(1)(2)
Siemens/Talon						
	OH/UG	WMM#1225RB (2-5 position)	Horn	PANEL	100kA	(1)
Square D						
	OH/UG	EZMH11#225 (2-5 position)	Horn	PANEL	10kA	(1)
120/208V 1PH-in, 1PH-out 5-Terminal 100 Amp						
Siemens/Talon						
	OH/UG	WMM21125RJB (2 position)	Horn	WALL	65kA	
120/208V 1PH-in, 1PH-out 5-Terminal 200 Amp						
Siemens/Talon						
	OH/UG	WMM21225RJB (2 position)	Horn	WALL	100kA	
120/208V 3PH-in, 1PH-out 5-Terminal 100 Amp						
Eaton-CH						
	OH/UG	3MM#12RRLB (2-5 Position)	Horn	PANEL	10kA	(1)
GE						
	OH/UG	TMPR8#12RHB (2-5 position)	Horn	PANEL	10kA	(1)
Siemens/Talon						
	OH/UG	WMM#2125RJB (2-5 position)	Horn	WALL	65kA	(1)
	OH/UG	WML#2125RJ (2-5 position)	Lever	WALL	65kA	(1)
Square D						
	OH/UG	EZMH31#125 (3-5 position)	Horn	PANEL	10kA	(1)
120/208V 3PH-in, 1PH-out 5-Terminal 200 Amp						
Eaton-CH						
	OH/UG	3MM#20RRLB (2-4 Position)	Horn	PANEL	10kA	(1)
Erickson Electric						
	OH/UG	3RM**4-# (2-4 position)	Horn	PANEL	10kA	(1)(2)
GE						
	OH/UG	TMPR8#20RHB (2-4 position)	Horn	PANEL	10kA	(1)
Siemens/Talon						
	OH/UG	WMM#2225RJB (3-5 position)	Horn	WALL	100kA	(1)
Square D						
	OH/UG	EZMH31#225 (2-5 position)	Horn	PANEL	10kA	(1)

NOTES:

- (1) # = Multiple catalog numbers, approved for positions as shown next to catalog number
- (2) ** = Select bus rating, see manufacturer drawing for details

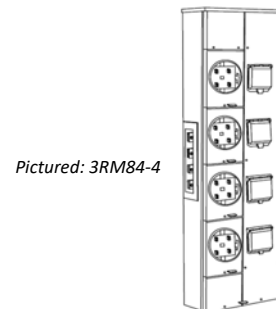

Pictured: 3RM84-4

ELECTRIC SERVICE EQUIPMENT

METER SOCKETS

Issued Jan 2024

Manufacturer	Use	Catalog Number	Bypass	Mount	SCCR	Notes
E302. Multi-position Commercial/Residential: Modular (bussed sections)						
120/240V 1PH-in, 1PH-out 4-Terminal 200 Amp						
Eaton-CH						
	OH/UG	35MM#20R12 (1-4 position)	Lever	PANEL	10kA	(1)
Siemens/Talon						
	OH/UG	WML#1225RJ (1-4 position)	Lever	PANEL	10kA	(1)
Square D						
	OH/UG	EZML11#225 (1-4 position)	Lever	PANEL	10kA	(1)(5)
120/208V 1PH-in, 1PH-out 5-Terminal 300 Amp						
Siemens/Talon						
	OH/UG	WML11400RJFS (1 position)	Lever	PANEL	100kA	
	OH/UG	WML11400RJH (1 position)	Lever	PANEL	35kA	
120/208V 3PH-in, 1PH-out 5-Terminal 200 Amp						
Eaton-CH						
	OH/UG	35MM#20R12 (1-4 position)	Lever	PANEL	10kA	(1)
Erickson Electric						
	OH/UG	CM**4-# (2-4 position)	Lever	PANEL	10kA	(1)(2)
GE						
	OH/UG	TMPR12#22R (1-4 position)	Lever	PANEL	10kA	(1)
Siemens/Talon						
	OH/UG	WMLZ#2125RJ (3-5 position)	Lever	PANEL	100kA	(1)
	OH/UG	WMLZF#2125RJ (3-5 position)	Lever	PANEL	100kA	(1)
	OH/UG	WLM#2225RJ (2-4 position)	Lever	WALL	100kA	(1)
Square D						
	OH/UG	EZML31#225 (1-4 position)	Lever	PANEL	10kA	(1)(5)
120/208V 3PH-in, 1PH-out 5-Terminal 300 Amp						
Eaton-CH						
	OH/UG	35MM#40R1240 (1-2 Position)	Lever	PANEL	10kA	(1)
Siemens/Talon						
	OH/UG	WML12400RJFS (1 position)	Lever	PANEL	100kA	
	OH/UG	WML12400RJH (1 position)	Lever	PANEL	35kA	
Square D						
	OH/UG	EZML31#400 (1-2 position)	Lever	PANEL	10kA	

NOTES:

- (1) # = Multiple catalog numbers, approved for positions as shown next to catalog number
- (2) ** = Select bus rating, see manufacturer drawing for details
- (5) EZML requires deep well end covers. Shallow end covers shall never be used.

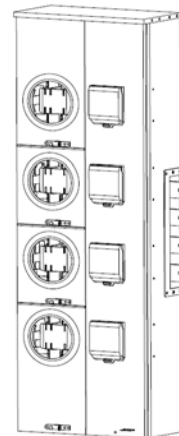

Pictured: CM87-4

ELECTRIC SERVICE EQUIPMENT

METER SOCKETS

Issued Jan 2024

Manufacturer	Use	Catalog Number	Bypass	Mount	SCCR	Notes
E302. Multi-position Commercial/Residential: Modular (bussed sections) (continued)						
120/208V 3PH-in, 3PH-out 7-Terminal 200 Amp						
Eaton-CH						
	OH/UG	37MM#20R12 (1-4 Position)	Lever	PANEL	10kA	(1)
Erickson Electric						
	OH/UG	CM**7-# (2-4 position)	Lever	PANEL	10kA	(1)(2)
GE						
	OH/UG	TMPR312#22R (1-4 position)	Lever	PANEL	10kA	(1)
Siemens/Talon						
	OH/UG	WML#3225RJ (1-4 position)	Lever	PANEL	100kA	(1)
Square D						
	OH/UG	EZML33#225 (1-4 position)	Lever	PANEL	10kA	(1)(5)
120/208V 3PH-in, 3PH-out 7-Terminal 300 Amp						
Eaton-CH						
	OH/UG	37MM#40R1240 (1-2 Position)	Lever	PANEL	10kA	(1)
GE						
	OH/UG	TMPR312#40TR (see note)	Lever	PANEL	10kA	(3)
	OH/UG	TMPR312140RB (see note)	Lever	PANEL	10kA	(4)
Siemens/Talon						
	OH/UG	WML#3400RJ (1-2 position)	Lever	PANEL	25kA	(1)
	OH/UG	WML13400RJFS (1 position)	Lever	PANEL	100kA	
	OH/UG	WML13400RJH (1 position)	Lever	PANEL	35kA	
Square D						
	OH/UG	EZML33#400 (1-2 position)	Lever	PANEL	10kA	(1)(5)

NOTES:

- (1) # = Multiple catalog numbers, approved for positions as shown next to catalog number
- (2) ** = Select bus rating, see manufacturer drawing for details
- (3) Requires two tenant breakers with maximum sum of 300A. Cannot be used to serve a single 300A main.
- (4) Requires 300 amp tenant breaker to be installed.
- (5) EZML requires deep well end covers. Shallow end covers shall never be used.

Pictured: WML13400RJ

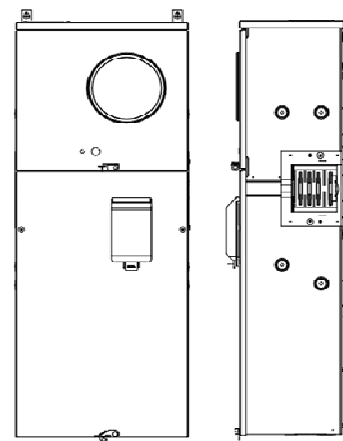

ELECTRIC SERVICE EQUIPMENT

CABINETS

Issued Jan 2024

Manufacturer	Catalog Number	Main Size	SCCR	Notes	Top In	Bottom In	Pad-mount
E303A. Bussed Metering Transformer Cabinets w/Main - 400A							
120/240V 1PH-in, 1PH-out 400 Amp WALL							
Eaton-CH							
	CTAP3244NCM8-CH11	2-200			X	X	
	CTAP325NCM8-CH11	400			X	X	
	CTAT325NCM8-CH11	400			X	X	
Erickson Electric							
	ALI-CT*-P-3244N-CM**	2-200		(2)(6)	X	X	
	ALI-CT*-DK-325N-CM**	400		(2)(6)	X	X	
	ALI-CT*-P-325N-CM**	400		(2)(6)	X	X	
	ALI-CT*-T-325N-CM**	400		(2)(6)	X	X	
120/208V 3PH-in, 3PH-out 400 Amp WALL							
Eaton-CH							
	CTAP4244NCM8-CH	2-200			X	X	
	CTAP425NCM8-CH	400			X	X	
	CTAT425NCM8-CH	400			X	X	
Erickson Electric							
	ALI-CT*-P-4244N-CM**	2-200		(2)(6)	X	X	
	ALI-CT*-DK-425N-CM**	400		(2)(6)	X	X	
	ALI-CT*-T-425N-CM**	400		(2)(6)	X	X	
	ALI-CT*-P-425N-CM**	400		(2)(6)	X	X	
277/480V 3PH-in, 3PH-out 400 Amp WALL							
Erickson Electric							
	ALI-CT*-KD-465N-PT-6CM**	400		(2)(6)	X	X	
	ALI-CT*-P-465-PT-6CM**	400		(2)(6)	X	X	
	ALI-CT*-T-465N-PT-6CM**	400		(2)(6)	X	X	
E303B. Bussed Termination Boxes - 400A							
120/240V 1PH-in, 1PH-out 400 Amp WALL							
Eaton-CH							
	ALI-TRB325N-CH				X	X	
Erickson Electric							
	ALI-TRB325N				X	X	
120/208V 3PH-in, 3PH-out 400 Amp WALL							
Eaton-CH							
	ALI-TRB425N-CH				X	X	
Erickson Electric							
	ALI-TRB425N				X	X	
277/480V 3PH-in, 3PH-out 400 Amp WALL							
Erickson Electric							
	ALI-TRB465N				X	X	
E303C. Bussed Termination Boxes w/Main - 400A							
120/240V 1PH-in, 1PH-out 400 Amp WALL							
Siemens (Required Lug Kit)							
	WEB1400B	(LK12500N2)	400	65kA		X	
	WEB1400BU	(LK12500N2)	400	100kA		X	
	WES1400BU	(LK12500N2)	400	100kA		X	
120/208V 3PH-in, 3PH-out 400 Amp WALL							
Siemens (Required Lug Kit)							
	WEB3400B	(LK32500N2)	400	100kA		X	
	WEB3400BU	(LK32500N2)	400	65kA		X	
	WES3400BU	(LK32500N2)	400	100kA		X	

- (2) ** = Select bus rating, see manufacturer drawing for details
- (6) Fill in * with A for Top In / Bottom Out or B for Bottom In / Top Out

Pictured:
ALI-CTA-P-425N-CM8



Pictured:
ALI-TRB425N



Pictured:
WEB3400BUB3



ELECTRIC SERVICE EQUIPMENT

CABINETS

Issued Jan 2024

Manufacturer	Catalog Number	Main Size	SCCR	Notes	Top In	Bottom In	Pad-mount
E304A. Bussed Metering Transformer Cabinets w/Main - 600A							
120/240V 1PH-in, 1PH-out 600 Amp WALL							
Eaton-CH							
	CTAT326NCM8-CH11	400			X	X	
Erickson Electric							
	ALI-CT*-LD-326N-CM**	600		(2)(6)	X	X	
	ALI-CT*-T-326N-CM**	600		(2)(6)	X	X	
120/208V 3PH-in, 3PH-out 600 Amp WALL							
Eaton-CH							
	CTAT426NCM8-CH	600			X	X	
Erickson Electric							
	ALI-CT*-LD-426N-CM**	600		(2)(6)	X	X	
	ALI-CT*-T-426N-CM**	600		(2)(6)	X	X	
277/480V 3PH-in, 3PH-out 600 Amp WALL							
Erickson Electric							
	ALI-CT*-LD-466N-PT-6CM**	600		(2)(6)	X	X	
	ALI-CT*-T-466N-PT-6CM**	600		(2)(6)	X	X	
E304B. Bussed Termination Boxes - 600A							
120/240V 1PH-in, 1PH-out 600 Amp WALL							
Eaton-CH							
	ALI-TRB326N-CH				X	X	
Erickson Electric							
	ALI-TRB326N				X	X	
120/208V 3PH-in, 3PH-out 600 Amp WALL							
Eaton-CH							
	ALI-TRB426N-CH				X	X	
Erickson Electric							
	ALI-TRB426N				X	X	
277/480V 3PH-in, 3PH-out 600 Amp WALL							
Erickson Electric							
	ALI-TRB466N				X	X	
E304C. Bussed Termination Boxes w/Main - 600A							
120/240V 1PH-in, 1PH-out 600 Amp WALL							
Siemens (Required Lug Kit)							
	WEB1600BU (LK12500N2E)	600	100kA			X	
	WEB1600B (LK12500N2E)	600	65kA			X	
	WES1600BU (LK12500N2E)	600	100kA			X	
120/208V 3PH-in, 3PH-out 600 Amp WALL							
Siemens (Required Lug Kit)							
	WEB3600BU (LK32500N2E)	600	100kA			X	
	WEB3600B (LK32500N2E)	600	65kA			X	
	WES3600BU (LK32500N2E)	600	100kA			X	

(2) ** = Select bus rating, see manufacturer drawing for details
 (6) Fill in * with A for Top In / Bottom Out or B for Bottom In / Top Out

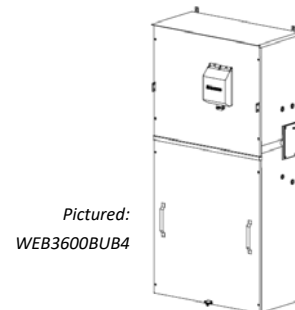
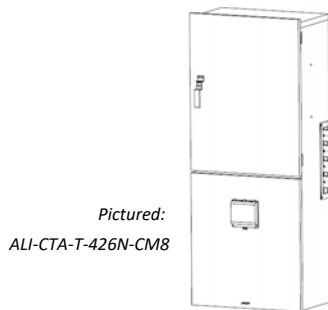

ELECTRIC SERVICE EQUIPMENT

CABINETS

Issued Jan 2024

Manufacturer	Catalog Number	Main Size	SCCR	Notes	Top In	Bottom In	Pad-mount
E305A. Bussed Metering Transformer Cabinets w/Main - 800A							
120/240V 1PH-in, 1PH-out 800 Amp WALL							
Eaton-CH							
	CTAT327NCM8-CH11	400			X	X	
Erickson Electric							
	ALI-CT*-MD-327N-CM**	800		(2)(6)	X	X	
	ALI-CT*-T-327N-CM**	800		(2)(6)	X	X	
120/208V 3PH-in, 3PH-out 800 Amp WALL							
Eaton-CH							
	CTAT427NCM8-CH	800			X	X	
Erickson Electric							
	ALI-CT*-MD-427N-CM**	800		(2)(6)	X	X	
	ALI-CT*-T-427N-CM**	800		(2)(6)	X	X	
277/480V 3PH-in, 3PH-out 800 Amp WALL							
Erickson Electric							
	ALI-CT*-MD-467N-PT-6CM**	800		(2)(6)	X	X	
	ALI-CT*-T-467N-PT-6CM**	800		(2)(6)	X	X	
E305B. Bussed Termination Boxes - 800A							
120/240V 1PH-in, 1PH-out 800 Amp WALL							
Eaton-CH							
	ALI-TRB327N-CH				X	X	
Erickson Electric							
	ALI-TRB327N				X	X	
Siemens (Required Lug Kit)							
	WET1800BU	(LK33750N2E)	100kA			X	
120/208V 3PH-in, 3PH-out 800 Amp WALL							
Eaton-CH							
	ALI-TRB427N-CH				X	X	
Erickson Electric							
	ALI-TRB427N				X	X	
Siemens (Required Lug Kit)							
	WET3800BU	(LK35600N2)	100kA			X	
277/480V 3PH-in, 3PH-out 800 Amp WALL							
Erickson Electric							
	ALI-TRB467N				X	X	
E305C. Bussed Termination Boxes w/Main - 800A							
120/240V 1PH-in, 1PH-out 800 Amp WALL							
Siemens (Required Lug Kit)							
	WEB1800BU	(LK13500N2)	800	100kA		X	
	WEB1800B	(LK13500N2)	800	65kA		X	
	WES1800BU	(LK13500N2)	800	100kA		X	
120/208V 3PH-in, 3PH-out 800 Amp WALL							
Siemens (Required Lug Kit)							
	WEB3800BU	(LK33500N2)	800	100kA		X	
	WEB3800B	(LK33500N2)	800	65kA		X	
	WES3800BU	(LK33500N2)	800	100kA		X	

NOTES:

- (2) ** = Select bus rating, see manufacturer drawing for details
- (6) Fill in * with A for Top In / Bottom Out or B for Bottom In / Top Out

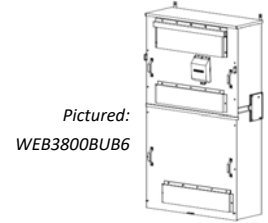
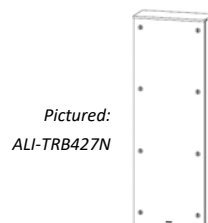
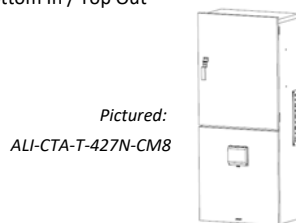

ELECTRIC SERVICE EQUIPMENT

CABINETS

Issued January 2024

Manufacturer	Catalog Number	Main Size	SCCR	Notes	Top In	Bottom In	Pad-mount
E306A. Bussed Metering Transformer Cabinets w/Main - 1200A							
120/208V 3PH-in, 3PH-out 1200 Amp WALL							
Eaton-CH							
	ALI-TRB428N-CH				X	X	
Erickson Electric							
	ALI-TRB428N				X	X	
Siemens (Required Lug Kit)							
	WET31200BU	(LK33750N2E)	100kA			X	
277/480V 3PH-in, 3PH-out 1200 Amp WALL							
Erickson Electric							
	ALI-TRB468N				X	X	
E306C. Bussed Termination Boxes w/Main - 1200A							
120/208V 3PH-in, 3PH-out 1200 Amp WALL							
Siemens (Required Lug Kit)							
	WEB31200B	(LK34500N2E)	1200	65kA		X	
	WEB31200BU	(LK34500N2E)	1200	100kA		X	
	WEBM31200B	(LK34500N2E)	1200	65kA		X	
	WEBM31200BU	(LK34500N2E)	1200	100kA		X	
	WES31200BU	(LK34500N2E)	1200	100kA		X	

Pictured:
ALI-TRB428N



Pictured:
WEB31200BUB9

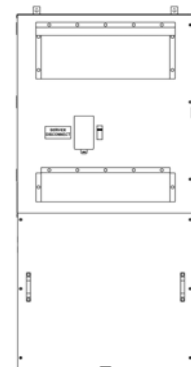



ELECTRIC SERVICE EQUIPMENT

METER SOCKETS

Issued January 2024

Manufacturer	Catalog Number	Meter	Bypass	Mount	SCCR	Notes
E307. Electric Vehicle Charger Metering Transformer Cabinets						
277/480V 3PH 200 Amp Cabinet 13-Terminal 20 Amp Socket PAD						
Milbank						
UG	CP3B5281	(blank)	Test Sw.	PAD	10kA	(7)
277/480V 3PH 400 Amp Cabinet 13-Terminal 20 Amp Socket PAD						
Milbank						
UG	CP3F0481	UC7449-XL (WP&L)	Test Sw.	PAD	10kA	(7)
UG	CP3F0481	UC7449-XL-871-ALT (IP&L)	Test Sw.	PAD	10kA	(7)
277/480V 3PH 800 Amp Cabinet 13-Terminal 20 Amp Socket PAD						
Milbank						
UG	CP3B681	UC7449-XL (WP&L)	Test Sw.	PAD	10kA	(7)
UG	CP3B681	UC7449-XL-871-ALT (IP&L)	Test Sw.	PAD	10kA	(7)
E308. (SECTION NOT USED)						
(blank)						

Notes:

(7) Requires two tenant breakers with maximum sum of 300A. Cannot be used to serve a single 300A main. (GE)



E309. SWITCHBOARD STRUCTURES - 400 TO 3000 AMPS

- All switchboard structures, due to their customizable nature, shall include detailed drawings with applicable dimensions. These drawings shall be submitted to and approved by Alliant Energy distribution engineering and metering prior to ordering.
- All instrument transformer rated meter socket locations shall be approved by Alliant Energy Electric Meter Technician prior to installation.
- All switchboard structures will be reviewed on site to verify they meet pre-approved project drawings before Alliant Energy will install metering equipment.

A. GENERAL REQUIREMENTS & ACCEPTANCE

1. Switchboards shall be approved, listed by and meet requirements of UL 891.
2. As a minimum requirement, the switchboard shall carry a NEMA 3R rating.
3. All switchboard sections shall be bonded to neutral.
4. All switchboards shall be pad-mounted, bottom-in/bottom-out or bottom-in/top-out. Pad shall provide required workspace, 48", in front of metering equipment.
5. All switchboard installations require a concrete pad a minimum of 8" thick. Additional foundation walls shall be used for locations having poor soil conditions.
6. Refer to ESR e-manual 606 for clearance requirements.
7. Side-hinged doors^③ with two or three-point locking handle with a minimum 7/16 inch diameter sealing hole to accept Alliant Energy padlock with 3/8 inch shackle are required for direct working access to the termination section and instrument transformer sections.
8. All door(s) covering metering equipment shall have a lockable wind-stop assembly installed and shall open 90 degrees without hitting any obstructions. Wind-stops shall be designed with no possibility of coming in contact with energized bus or equipment.
9. No fasteners shall be able to be removed from the exterior of the cabinet. Switchboard installations shall be designed with captive type hardware.
10. All trim panels shall be secured by tamper proof mechanical means.
11. A main disconnect is required if greater than six disconnects exist in switchboard. (NEC 230.71 and 230.2).
12. Self-contained metering and instrument transformer metering equipment shall not be installed in the same sections. A separate termination section is also required.
13. It shall be understood that unless a lockable disconnect is installed before each instrument transformer rated compartment, an outage to the entire switchboard may be required for installation, maintenance or disconnection of any single instrument transformer section.
14. All switchboards shall be reviewed and approved by Alliant Energy to ensure they meet our requirements. Alliant Energy will not approve the use of altered, rusted, damaged or modified equipment.

ELECTRIC SERVICE EQUIPMENT

ADDITIONAL EQUIPMENT INFORMATION

Issued Jan 2024

B. TERMINATION SECTION

1. Termination section shall have a minimum width of 42”.
2. A minimum height of 35” is and maximum height of 60” is required from the termination lugs to the floor. Cable supports shall be provided so full weight of utility cables is not supported by lugs. Lugs for all phases and neutral may be located at same level or staggered.
3. Lugs^⑤ shall be rated to accept conductor sizes:
 - a) 4/0 to 500kcmil (400 to 1200A switchboards)
 - b) 500 to 1000kcmil (1600 to 3000A switchboards)
4. Grounding studs/straps are required in termination bay.

C. SELF-CONTAINED METERING SECTION

120/240V, 120/208V & 277/480V Installations

1. Self-contained metering section shall have a minimum width of 32”.
2. All meters shall be visible from outside of switchboard and shall not be behind doors.
3. All self-contained meter sockets^④ shall be lever bypass.
4. Meter sockets shall meet standard multi-metering height of 2’-6” minimum, 6’-0” maximum measured from the floor to the center of the meter.
5. Maximum number of meters per section depends on how many meters can be safely installed within the standard multi-metering height requirements.
6. A 6” spacer section is required whenever a 6” clearance from meter socket glass to a cabinet cannot be obtained. Reference: ESR e-manual 612C Note 4 and ESR e-manual 612D Note 3.

277/480V Installations - Additional Requirements

1. Self-contained meters shall be cold sequence (**Switch-Meter-Switch-Fuse**)
2. Non-fused load break switches are required before a meter; pull-out blocks are not allowed.

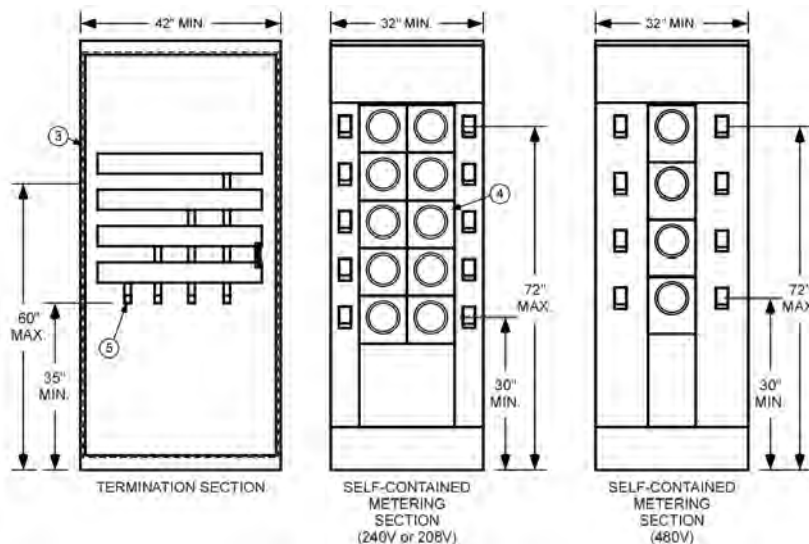

Drawings for reference purposes only, actual drawings may vary by manufacturer

D. INSTRUMENT TRANSFORMER SECTION

120/240V & 120/208V Installations

1. Instrument transformer section shall have 42" Minimum section width.
2. Current transformers (CTs) ² shall be located behind a hinged, solid one-piece door ³ the full width of the section for ease of access. Needing to remove multiple doors or panels to access instrument transformers is not allowed.
3. CTs shall be at a minimum height of 36" and a maximum height of 60", measured from the floor to the center line of the CTs.
4. Services rated at 1000A and below, use CTs with a 2-bolt pattern, the CTs shall be mounted so the terminal connections are facing outward. All single bar installations shall have bolts stamped in place.
5. Meter shall be in an Alliant Energy approved meter socket listed in ESE e-manual Section E105. Contact Alliant Energy Electric Meter Technician to determine location of instrument transformer rated meter socket.
6. All current transformer sequencing shall be labeled line and load.
7. A bonding lug is required in each instrument transformer compartment for the meter socket and a neutral tap is required for each instrument transformer compartment.
8. Only one instrument transformer compartment will be acceptable per section for instrument transformer installations rated 1200A and higher. Two instrument transformer compartments may be considered in a single section if the sum of the ratings of the two compartments is 1200A or less. (i.e. (1):400A & (1):800A, or (2):600A compartments)
9. All metering cables shall exit the metering section and not go through any other sections unless the cable is in its own conduit and approved by Alliant Energy Electric Meter Technician. No metering conduit shall run underground.

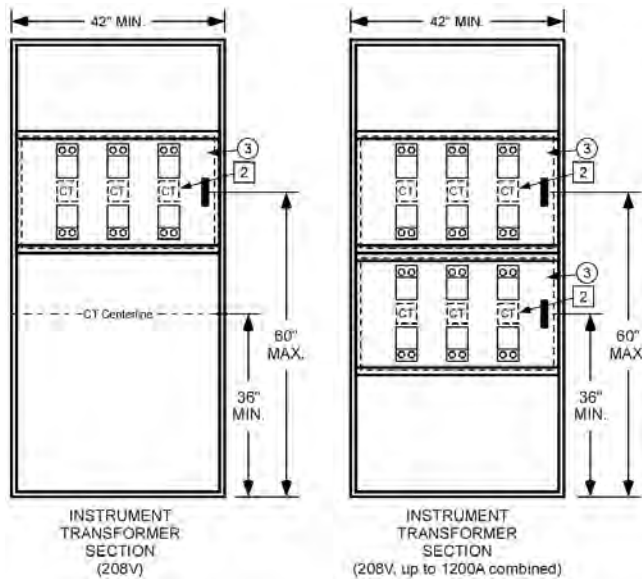

Drawings for reference purposes only, actual drawings may vary by manufacturer

ELECTRIC SERVICE EQUIPMENT

ADDITIONAL EQUIPMENT INFORMATION

Issued Jan 2024

277/480V Installations

1. Instrument transformer section shall have 42" Minimum section width.
2. Instrument transformer compartment shall be at a minimum height of 36" and a maximum height of 60", measured from the floor to the center line of the CTs.
3. Potential transformers (PTs)¹ (480V) and Current transformers (CTs)² shall be located behind a hinged, solid one-piece door³ the full width of the section for ease of access. Having to remove multiple doors or panels to access instrument transformers is not allowed.
4. Removable mounting plate shall be provided for PTs to be positioned with the metering compartment. The PT mounting plate shall be secured in such a manner that the plate is self-supporting while final securement devices are installed.
5. PTs and CTs shall be mounted so the terminal connections are facing out.
6. Services rated at 1000A and below, use CTs with a 2-bolt pattern, the CTs shall be mounted so the terminal connections are facing outward. All single bar installations shall have bolts stamped in place.
7. Meter shall be in an Alliant Energy approved meter socket listed in ESE e-manual Section E105. Contact Alliant Energy Electric Meter Technician to determine location of instrument transformer rated meter socket.
8. All current transformer sequencing will be bottom line and to top load mounting and labeled line and load.
9. A bonding lug is required in each instrument transformer compartment for the meter socket and a neutral tap is required for each instrument transformer compartment.
10. Only one instrument transformer compartment will be acceptable per section.
11. All metering cables shall exit the metering section and not go through any other sections unless the cable is in its own conduit and approved by Alliant Energy Electric Meter Technician. No metering conduit shall run underground.

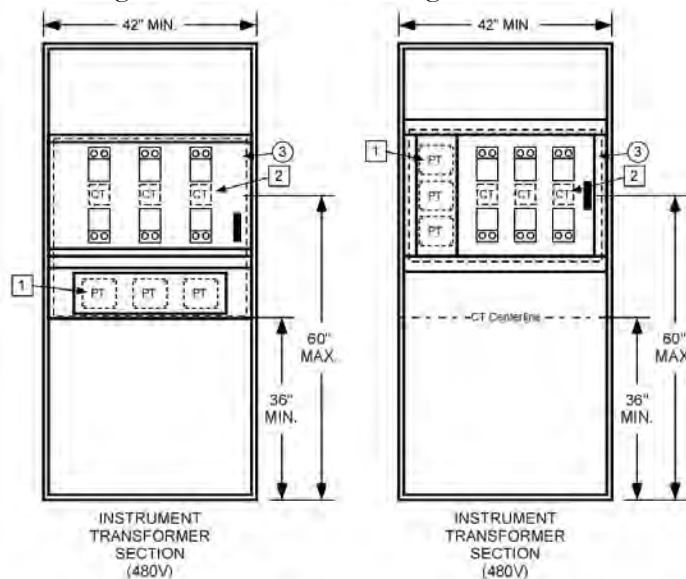

Drawings for reference purposes only, actual drawings may vary by manufacturer



E310. PRIMARY METERING ENCLOSURES

All primary service equipment, including the options listed below, shall be submitted to and approved by Alliant Energy engineering and metering prior to ordering and installation.

See [Electric Service Rules e-manual \(ESR\) Chapter 10](#) for more information regarding Primary Metering.

A. DEADFRONT PRIMARY METERING ENCLOSURES – 25 kV (See [ESR e-manual 1001](#))

WI - Alliant Energy provides CT's, PT's and PT fuses to manufacturer

IA - Alliant Energy may install CT's, PT's and PT fuses in enclosure

Durham - Cabinet Number: APX322511-ALI
APX362511-ALI
APX122511-ALI

Order through Border States Customer Service 866-483-7289.

B. PRIMARY METERING SWITCHGEAR – 25 kV (See [ESR e-manual 1002](#))

Switchgear Drawings shall be submitted to Alliant Energy for approval before ordering.

RATINGS

1. All equipment shall carry a minimum fault current of 10,000 amps (RMS symmetrical)
2. Service disconnect shall be gang operated, be operable by both the customer and Alliant Energy and have means to show visual open contacts.
3. A single service disconnect may not be required. If six or fewer branch circuits are present, the service disconnect is not required by code.
Exception: If on-site generation is present, service disconnect (or isolation switch) is required regardless the number of branch circuits.
4. Customer-owned main fuses or breakers shall have adequate load carrying capacity and shall coordinate with Alliant Energy's system.
5. All bus and cable bracing shall have adequate strength to prevent movement or damage to bus or cable at a maximum fault level of 10,000 amps (RMS symmetrical).
6. Distribution lightning arrestors are required in termination bay with an 18kV rating. ^⑤

BUS/LINE SIDE LUG SPECIFICATIONS

1. A two-hole NEMA standard lug landing shall be provided for each service lateral cable in the termination bay including the neutral bus for Alliant Energy compression lugs. ^⑥
2. A minimum height of 54" is required from the termination lugs to the floor.

DOORS

1. Hinged doors ^⑪ with provisions for locking with an Alliant Energy padlock ^⑬ are required for direct working access to the termination bays and metering bays.
2. In the metering bay, a second wire mesh inner door ^⑫ shall be provided.

ELECTRIC SERVICE EQUIPMENT

ADDITIONAL EQUIPMENT INFORMATION

Issued Jan 2024

INSTRUMENT TRANSFORMERS

1. Metering transformer space shall be adequate for three voltage transformers (PTs)¹ and three current transformers (CTs)². Consult Alliant Energy metering for appropriate PTs and CTs, ordering procedure and shipment details to the manufacturer for installation.
2. Fuse holders will need to be provided for PT fuses⁴. Consult Alliant Energy metering for appropriate fuse holder type. Alliant Energy metering will supply the fuses³. The PTs shall be tapped on the source side of the CTs.
3. PTs and CTs shall be mounted on shelves⁹¹⁰ for ease of installation and replacement, such that the nameplates can be read from the front.
4. PT/CT drawers may be acceptable if they do not interfere with operation and maintenance.
5. The meter cable will be furnished and installed by Alliant Energy.
6. Lifting eyes¹⁴ shall be provided for CT installation.

GROUNDING

1. Grounding bails shall be provided for all three phases and the primary neutral bus in the termination bays and metering bays.⁷
2. If Alliant Energy is or will be under contract to operate and maintain customer owned switchgear, then grounding bails shall be provided in all bays of the switchgear.
3. All grounding shall meet requirements of NEC 250.⁸

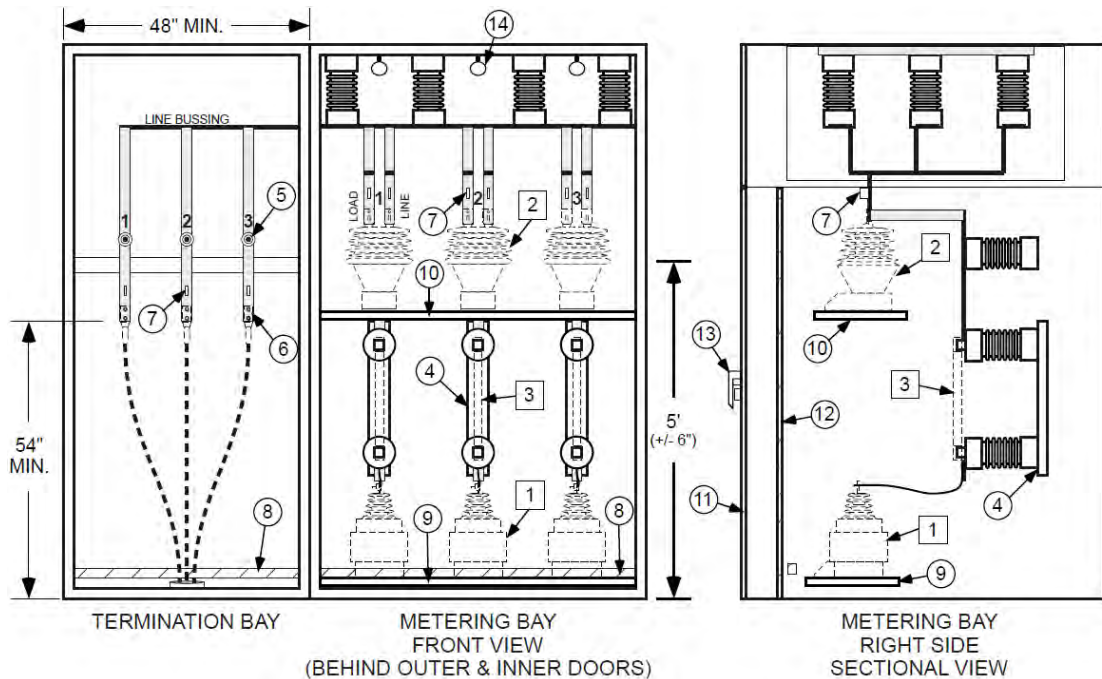



ELECTRIC SERVICE EQUIPMENT

ADDITIONAL EQUIPMENT INFORMATION

Issued Jan 2024

E311. TRANSFER SWITCHES (SITE ISOLATING DEVICES)

NOTE: Listed are Pole Top Transfer Switches (Site Isolating Devices) and Grade Level Transfer Switches with meter sockets. Other transfer switches, 600 volts or less, that meet all requirements of ESR e-manual Chapter 12, are UL listed and meet NEC requirements are allowed.

A. FARMSTEAD POLE TOP TRANSFER SWITCHES – 250 VOLT MAX. (NEC 547.2 Site-Isolating Device) MAINTENANCE ONLY

MANUFACTURER	SIZE (AMPS)	ITEM#	REMARKS
Ronk Electric Industries	400	9406	Single phase – 2 pole
	400	9806	Three phase – 3 pole
	800	R8208	Single phase – 2 pole
	800	R8808	Three phase – 3 pole

B. FARMSTEAD POLE TOP TRANSFER SWITCHES – 600 VOLT MAX. (NEC 547.2 Site-Isolating Device) MAINTENANCE ONLY

MANUFACTURER	SIZE (AMPS)	ITEM#	REMARKS
Ronk Electric Industries	400	9808	Three phase – 3 pole
	800	R8808	Three phase – 3 pole

C. RESIDENTIAL GRADE LEVEL TRANSFER SWITCHES WITH METER SOCKET – 250 VOLT MAX.

MANUFACTURER	SIZE (AMPS)	ITEM#	REMARKS
Ronk Electric Industries	200	7215-MSH(*) – (**)	Single phase – 2 pole

Note: (*) = H/Horn Bypass or L/Lever Bypass. (***) = OH/Over Head, UG/Underground or SS/Side by Side (OH OR UG). Unit has 10,000 AIC rating only.

ELECTRIC SERVICE EQUIPMENT

ADDITIONAL EQUIPMENT INFORMATION

Issued Jan 2024

D. MANUALLY OPERATED GRADE LEVEL TRANSFER SWITCHES – 250 VOLT MAX.

<u>MANUFACTURER</u>	<u>SIZE (AMPS)</u>	<u>ITEM#</u>	<u>REMARKS</u>
Ronk – Double Throw Switch	100	7103	2-Poles
	100	4102SE	2-Poles
	100	4103SE	3-Poles
	100	4104	4-Poles
	100	5102-SE*	2-Poles
	100	5103-SE*	3-Poles
	100	5104	4-Poles
Ronk – Double Throw Switch	200	7205	2-Poles
	200	4202SE	2-Poles
	200	4203SE	3-Poles
	200	4024	4-Poles
	200	5202-SE*	2-Poles
	200	5203-SE*	3-Poles
	200	5204	4-Poles
	200	5303-SE*	3-Poles
	200	5304	4-Poles
Ronk – Double Throw Switch	400	4402SE	2-Poles
	400	4403SE	3-Poles
	400	4404	4-Poles
	400	5402-SE*	2-Poles
	400	5403-SE*	3-Poles
	400	5404	4-Poles
Ronk – Double Throw Switch	600	4063SE	3-Poles
	600	4604	4-Poles
	600	5803-SE*	3-Poles
	600	5804	4-Poles
Ronk – Double Throw Switch	700	5803-SE*	3-Poles
	700	5804	4-Poles
Ronk – Double Throw Switch	800	4803-SE*	3-Poles
	800	4804	4-poles
Ronk – Double Throw Switch	1200	4903	3-Poles
	1200	4904	4-Poles



Chapter 3

ELECTRIC SERVICE EQUIPMENT

ADDITIONAL EQUIPMENT INFORMATION

Issued Jan 2024

Manufacture	Size (AMPS)	240Volt / 1 Phase- 3 wire	240Volt / 3 Phase- 4 wire	600Volt / 3 Phase- 4 wire	L=Line Lugs Included LL=Load Lugs Included
A.M.P	200	ALISEDT224-4N	ALISEDT324-4N	ALISEDT364-4N	1L/1LL
A.M.P	400	ALISEDT225-5N	ALISEDT325-5N	ALISEDT365-5N	1L/1LL
A.M.P	600	ALISEDT226-6N	ALISEDT326-6N	ALISEDT366-6N	2L/2LL
A.M.P	800	ALISEDT227-7N	ALISEDT327-7N	ALISEDT367-7N	2L/2LL
A.M.P	1200		ALISEDT328-8N	ALISEDT368-8N	4L/4LL

Manufacture	Size (AMPS)	600Volt / 3PH – 4 Wire	250Volt / 1PH- 3 Wire	L=Line Lugs Included C= Camlocks Included
A.M.P	200	ALIGTCDTWC2-4A	ALIGTCDTWC2-3A	1L/1C
A.M.P	400	ALIGTCDTWC4-4A	ALIGTCDTWC4-3A	1L/1C
A.M.P	600	ALIGTCDTWC6-4C	ALIGTCDTWC6-3C	2L/2C
A.M.P	600	ALIGTCDTPC6-4A	ALIGTCDTPC6-3A	2L/2C
A.M.P	800	ALIGTCDTPC8-4A	ALIGTCDTPC8-3A	2L/2C
A.M.P	1200	ALIGTCDTPC12-4A	ALIGTCDTPC12-3A	4L/3C
A.M.P	1600	ALIGTCDTPC16-4A	ALIGTCDTPC16-3A	5L/4C
A.M.P	2000	ALIGTCDTPC20-4A	ALIGTCDTPC20-3A	6L/5C
A.M.P	2500	ALIGTCDTPC25-4A	ALIGTCDTPC25-3A	7L/7C
A.M.P	3000	ALIGTCDTPC30-4A	ALIGTCDTPC30-3A	8L/8C

ELECTRIC SERVICE EQUIPMENT

ADDITIONAL EQUIPMENT INFORMATION

Issued Jan 2024

**E. LEVEL OPERATED - PRIMARY VOLTAGE (See [ESR e-manual 1003](#))
POLE TOP LOAD BREAK SWITCH**

<u>MANUFACTURER</u>	<u>SIZE (VOLTS)</u>	<u>ITEM#</u>	<u>REMARKS</u>
S&C	25KV	147413/ED-701	Three phase – 3 pole Gang Operated

**F. GRADE LEVEL AUTOMATIC TRANSFER SWITCHES - 240V, 300Amp Max.
(ESR e-manual 1202.D Exception 1)**

Requires permanent labeling with instructions how to isolate from utility in addition to any *NEC* required labeling. Approved for use on single-phase, self-contained metering applications, up to 300 Amps only. Adjustable breakers are prohibited, see [ESR e-manual 116.E](#).

Manufacturer	Item#	Remarks
Size (AMPS) 100		
Generac	RTSW100A3	100A Main, service rated ATS
	RXSW100A3	100A Main, service rated ATS
	RXG24SHA1	100A Main, service rated ATS, 24 circuit panelboard
	CXSW100A3	100A Main, service rated ATS, customer wire only
Ronk	VTS01001240SX	100A Main, service rated ATS, single-phase
	ATS10012	100A Main, Optional Standby, service rated ATS
Kohler	RXT-JFNC-0100ASE	100A Main, service rated ATS
Briggs & Stratton	071100	100A Main, service rated ATS
	071071	100A Main, service rated ATS w/ symphony II
	071210	100A Main, service rated ATS
	071211	100A Main, service rated ATS w/ InfoHub Wifi
Champion	102009	100A Main, service rated ATS
Size (AMPS) 150		
Generac	RTSW150A3	150A Main, service rated ATS
	RXSW150A3	150A Main, service rated ATS
Briggs & Stratton	071150	150A Main, service rated ATS
	071070	150A Main, service rated ATS w/Symphony II
	071250	150A Main, service rated ATS



Chapter 3

ELECTRIC SERVICE EQUIPMENT

ADDITIONAL EQUIPMENT INFORMATION

Issued Jan 2024

	071251	150A Main, service rated ATS w/InfoHub WiFi
Kohler	RXT-JFNC-0150ASE	150A Main, service rated ATS
Champion	102008	150A Main, service rated ATS
Size (AMPS) 200		
Generac	RTSW200A3	200A Main, service rated ATS
	RXSW200A3	200A Main, service rated ATS
	RXG42SHA1	200A Main, service rated ATS
	RXEMW200A3	200A Main, service rated ATS
	RXSW200A3F	200A Main, service rated ATS, 8 circuit panelboard, rural applications (ESR 804B)
	CXSW200A3	200A Main, service rated ATS, customer wire only
Ronk	VTS02001240SX	200A Main, service rated ATS
	ATS20012	200A Main, service rated ATS, Optional Standby
Briggs & Stratton	071200	200A Main, service rated ATS
	071068	200A Main, service rated ATS w/Symphony II
	071270	200A Main, service rated ATS
	071271	200A Main, service rated ATS w/InfoHub WiFi
	071095	200A Main, service rated ATS, DirectPower
Kohler	RXT-JFNC-0200ASE	200A Main, service rated ATS
	RDT-CFNC-0200ASE	200A Main, service rated ATS
	RDT-CFNC-0200BSE	200A Main, service rated ATS, 42 Circuit panelboard
Champion	102006	200A Main, service rated ATS
Size (AMPS) 300		
Generac	RTSW300A3	300A Main, service rated ATS
	RXSW300A3	300A Main, service rated ATS (ESR e-manual 116E)
	RXT-JFNC-0300ASE	300A Main, service rated ATS (ESR e-manual 116E)

ELECTRIC SERVICE EQUIPMENT

ADDITIONAL EQUIPMENT INFORMATION

Issued Jan 2024

G1. GRADE LEVEL AUTOMATIC TRANSFER SWITCHES - 240V, SINGLE PHASE.

(ESR e-manual 1202.D Exception 1)

Requires permanent labeling with instructions how to isolate from utility in addition to any *NEC* required labeling. Approved for use on single-phase. Adjustable breakers are prohibited, see [ESR e-manual 116.E](#).

Size (AMPS) 400		
Generac	RTSW400A3	400A Main, service rated ATS
Ronk	VTS04001240SX	400A Main, service rated ATS
	ATS40012	400A Main, service rated ATS, Emergency Standby
Size (AMPS) 600		
Ronk	VTS06001240SX	600A Main, service rated ATS,
Ronk	ATS60012	600A Main, service rated ATS, Emergency Standby

G2. GRADE LEVEL AUTOMATIC TRANSFER SWITCHES - 480V, SINGLE PHASE.

(ESR e-manual 1202.D Exception 1)

Requires permanent labeling with instructions how to isolate from utility in addition to any *NEC* required labeling. Approved for use on single-phase. Adjustable breakers are prohibited, see [ESR e-manual 116.E](#).

Size (AMPS) 400		
Generac	RTSW400A3	400A Main, service rated ATS
Ronk	VTS04001240SX	400A Main, service rated ATS
Ronk	ATS40014	400A Main, service rated ATS, Emergency Standby
Size (AMPS) 600		
Ronk	VTS06001240SX	600A Main, service rated ATS
Ronk	ATS60014	600A Main, service rated ATS, Emergency Standby



H1. GRADE LEVEL AUTOMATIC TRANSFER SWITCHES - 240V, THREE-PHASE.

(ESR e-manual 1202.D Exception 1)

Requires permanent labeling with instructions how to isolate from utility in addition to any *NEC* required labeling. Approved for use on three-phase. Adjustable breakers are prohibited, see [ESR e-manual 116.E](#).

Size (AMPS) 100		
Ronk	ATS10032	100A Main, service rated ATS, Emergency Standby,
Size (AMPS) 200		
Ronk	ATS20032	200A Main, service rated ATS, Emergency Standby
Size (AMPS) 400		
	VTS04003208SX	400A Main, service rated ATS
	ATS40032	400A Main, service rated ATS Emergency Standby
Size (AMPS) 600		
	VTS06003208SX	600A Main, service rated ATS
Ronk	ATS60032	600A Main, service rated ATS Emergency Standby

H2. GRADE LEVEL AUTOMATIC TRANSFER SWITCHES - 480V, THREE-PHASE.

(ESR e-manual 1202.D Exception 1)

Requires permanent labeling with instructions how to isolate from utility in addition to any *NEC* required labeling. Approved for use on three-phase. Adjustable breakers are prohibited, see [ESR e-manual 116.E](#).

Size (AMPS) 400		
	VTS04003480SX	400A Main, service rated ATS
	ATS40034	400A Main, service rated ATS Emergency Standby
Size (AMPS) 600		
	VTS06003480SX	600A Main, service rated ATS
Ronk	ATS60034	600A Main, service rated ATS Emergency Standby



ELECTRIC SERVICE EQUIPMENT

ADDITIONAL EQUIPMENT INFORMATION

Issued Jan 2024

E312. UNDERGROUND SERVICE WIREWAYS

Approved for maintenance use and where standard conduits are impractical only.

MANUFACTURER	ITEM #
A.M.P.	WWPBXX & WWLPXX
Galva Closure	Model CC & CCL

E313. THREE PHASE PADMOUNT TRANSFORMER PADS

A. FIBERGLASS OR FIBERCRETE BOX PADS

Manufacturer	Catalog Number	Use	Number Phases	Box Pad Type	Box Pad Weight	Max Weight
					Lb	Lb
Pad A: 75 - 300 kVA Transformer						7,000
Electri-Glass	BP6000-24	UG	3	Resin/Fiberglass	250	
Nordic	GS-73-62-24RT-EB-MG-58x16	UG	3	Resin/Fiberglass/Plywood	375	
Electri-Mold (Hubbell)	BB6074241658600	UG	3		356	
Pad B: 500 - 750 kVA Transformer						9,000
Electri-Glass	BP11000-30	UG	3	Resin/Fiberglass	350	
Nordic	GS-72-80-30RT-2X-EB-MG-65x16	UG	3	Resin/Fiberglass/Plywood	630	
Electri-Mold (Hubbell)	BB7886361658600	UG	3		890	
Pad C: 1000 - 1500 kVA Transformer						13,000
Concast	FC-83-89-20-6421	UG	3	Fibercrete	1,138	
Pad D: 2000 - 2500 kVA Transformer						21,000
Concast	FC-85-122-20-7521	UG	3	Fibercrete	1,525	

B. PREFORMED CONCRETE PADS

Manufacturer	Catalog Number	Use	Number Phases	Box Pad Type
Pad I: 75 - 500 kVA Transformer				
Dalmaray	Pad I (Alliant Energy Specification)	UG	3	Concrete
Pad II: 750 - 2500 kVA Transformer				
Dalmaray	Pad II (Alliant Energy Specification)	UG	3	Concrete

E314. OVERHEAD TO UNDERGROUND SERVICE CONVERSION KIT

Approved for use when Alliant Energy is converting primary distribution line from overhead to underground and customer is fed from an existing overhead service.

Alliant Energy/Contractor will install, customer will take ownership.

<u>MANUFACTURER</u>	<u>CU CODE</u>
Milbank	MBRW

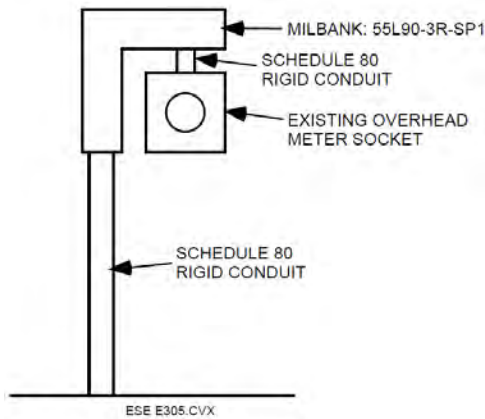

NOTES:

1. Conversion kit needs to be securely fastened to a wall
2. Crews will need to cut 2” holes in raceway for conduit
3. Existing service mast will be cut off to make room for conversion kit, retiring of the old service mast is the responsibility of the customer
4. If service lateral is in conduit, an expansion joint (not pictured) is also required